

KOMATSU

PC33E-6



Mini-excavator

ELECTRIC

Motor power
17.4 kW

Operating weight
3640 - 3820 kg

Bucket capacity
0.03 - 0.09 m³

PC33E-6



Motor power
17.4 kW

Operating weight
3640 - 3820 kg

Bucket capacity
0.03 - 0.09 m³



External DC charger
(Input: 400 V / 63 A) is standard

Industry leading characteristics providing unrivalled customer value

Powerful electric system

- Electric Komatsu powertrain
- 17.4 kW Komatsu electric motor
- 35 kWh Komatsu battery pack
- Long life battery design
- Fast battery charge (20 to 100%) in 1.8 h
- High voltage (115 V) architecture
- Increased lifting capacity: up to 30% over side (vs. PC33MR-5)
- Short tail design: 1020 mm tail swing radius

Environmentally friendly

- Zero local emissions
- Optimal for indoor use or to work outside of standard working hours
- Participate in low-carbon projects
- Support customers' environmental obligations
- Significantly lower noise and vibration levels (vs. PC33MR-5)
- Saves its own weight in CO₂ emissions per year (approx. 3.5 tonnes CO₂ saved compared to a diesel machine)

Total versatility

- Available with cab or canopy
- External DC charger (400 V)
- Proportional control for attachments
- Adjustable attachment oil flow
- Possibility to use market compatible hydraulic attachments

Komtrax

- Komatsu Wireless Monitoring System
- 4G mobile communications
- Includes battery status, charging, power consumption information

First-class comfort

- Air-suspended operator seat
- Multi-function monitor with redesigned interface for electric excavators
- Charging status information at a glance
- Machine controls are the same as Internal Combustion Engine machines (ICE) and offer familiar working behaviour

Safety first

- Heavy-duty, protected electric components
- High-safety LFP lithium battery design
- ROPS (ISO 3471) / OPG (ISO 10262) level 1 cab or canopy
- LED working lights
- Dual lock system for PPC controls through neutral position detection
- Secondary motor shutdown switch
- Seat belt caution indicator
- ID key (starter key with registered ID)
- Rear-view camera system (cab version)

Easy maintenance

- Air cooled maintenance-free electric motor and inverter
- Reduced daily check and periodical maintenance items
- Komatsu E-support program
- New electric powertrain components with a 5 year warranty
- Tilt-up floor for easier service access

Environmentally friendly electric system

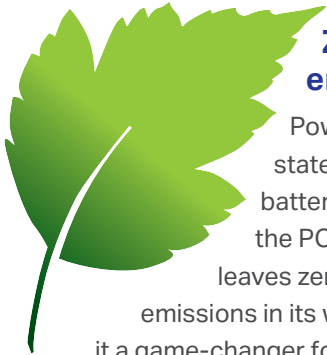

Zero emissions

Powered by state-of-the-art battery technology the PC33E-6 leaves zero local emissions in its wake, making it a game-changer for workers nearby and the surrounding environment. From indoor projects to bustling urban areas and landscaping endeavors, the almost noiseless PC33E-6 offers a solution that harmonizes with densely populated spaces, where emissions and noise pollution are paramount concerns. Incorporating this machine into your fleet is also opening the door to lucrative business opportunities. Clients today are increasingly prioritizing environmental sustainability, and the PC33E-6 empowers you to meet their eco-conscious demands.

35 kWh battery pack

The PC33E-6 boasts long-lasting lithium-ion batteries, ensuring minimal self-discharge and enduring charge cycles. Swift top-up charges during breaks enable uninterrupted operation, while maintenance-free batteries simplify upkeep. A vigilant battery management system provides real-time monitoring. Should power dwindle mid-operation, the display alerts the operator through a caution and prompts recharging via an alarm and output constraints. Additionally, the system safeguards against over-discharge and battery wear by monitoring and regulating temperature.

External DC charger

The 400 V external DC charger enables rapid, efficient charging, achieving a 20% to full recharge in just 1.8 hours. Komatsu's advanced charging control system ensures secure, high-capacity charging for peace of mind. Enhanced safety features include a locking mechanism that prevents accidental disconnection during charging. The operator can conveniently monitor the charging progress and access charger details on the user-friendly monitor screen.



ELECTRIC



Total versatility



Low-noise electric motor

The PC33E-6's whisper-quiet electric motor operates at an extremely low noise level, making it the ideal choice for noise-sensitive areas and allowing for work outside of standard hours without disruption.



8 working modes

Depending on the load, operators can conveniently choose between 8 working modes designed to match the type of work with energy-saving operation.



Lifting capacity boost

The short-tail PC33E-6 delivers all the power and digging speed you are used to from its Diesel counterpart. On top of this, the battery pack acts like a counterweight and boosts the lifting capacity over side by up to 30% (vs. PC33MR-5).

First-class comfort

Perfect operator convenience

The air-suspended operator seat provides excellent comfort. Fully adjustable proportional controls are fitted as standard for ergonomic, safe and precise operation of attachments. They are easy to use and the same as on conventional models. The automatic travel speed shift function allows smooth and efficient operation. Details like a 12-volt power port and a cup holder round off operator convenience.



Multi-function and rear-view monitors with redesigned interface for electric excavators

A high-definition 3.5" LCD monitor provides excellent visibility. The high-definition LCD panel is less affected by the viewing angle and surrounding brightness, ensuring excellent visibility. The monitor is specially designed to assist the operator in the use of an electric machine. Information such as battery charge, current power consumption and energy saving tips are displayed. A multitude of other energy-related status data are also provided. A separate rear-view monitor gives the operator a constant clear view of the area behind the machine, greatly improving safety.



Battery status and instantaneous power consumption (ECO gauge)

Displays the power consumed in the last three seconds and serves as a guide for energy-saving operation.



Operating modes

Easily select the operating modes according to the type of work.



Power consumption history

Check the power consumption history for the last 12 hours or one week.



Battery charging

When you connect the charge cable to the machine, the charge automatically starts.

Information & communication technology



Knowledge

You get quick answers to basic and critical questions about your machines – what they're doing, when they did it, where they're located, how they can be used more efficiently and when they need to be serviced. Performance data is relayed by wireless communication technology (satellite, GPRS or 4G depending on model) from the machine to a computer and to the local Komatsu distributor – who's readily available for expert analysis and feedback.

Convenience

Komtrax enables convenient fleet management on the web, wherever you are. Data is analysed and packaged specifically for effortless and intuitive viewing in maps, lists, graphs and charts. You can foresee eventual maintenance issues and required spare parts, and troubleshoot a problem before Komatsu technicians arrive on site.



The way to higher productivity

Komtrax uses the latest wireless monitoring technology. Compatible on PC, smartphone or tablet, it delivers insightful and cost saving information about your fleet and equipment, and offers a wealth of information to facilitate peak machine performance. By creating a tightly integrated web of support it allows proactive and preventive maintenance and helps to efficiently run a business.

Power

The detailed information that Komtrax puts at your fingertips 24 hours a day, 7 days a week gives the power to make better daily and long-term strategic decisions – at no extra cost. Problems can be anticipated, maintenance schedules customised, downtime minimised and machines kept where they belong: working on the jobsite.



Easy maintenance



Major reductions in daily inspections and regular maintenance

No inspection items for the engine or fuel means a major reduction in daily inspection and regular maintenance items. The air-cooled electric motor removes the need for coolant inspection and refilling in daily and regular inspections. Maintenance work can be done with peace of mind without worrying about oil and water leaks.



High-voltage area



Tilt-up floor

The canopy floor and operator compartment can be tilted up together if major maintenance is required.

Complete separation of areas for daily inspection and high-voltage area

The daily inspection areas and the high-voltage area are completely separate, with the latter concentrated in the rear of the body. Carry out daily inspections safely without worrying about high-voltage power sources.

Highest reliability and safety



Safe and proven electrical components

The electric system of the PC33E-6 features heavy-duty, protected, and vibration-proof components, along with a high-safety LFP lithium battery design, ensuring reliability and safety.

X-frame

The X-frame ensures maximum stress resistance and optimal stress distribution. Its shape makes the machine a lot more rigid and reliable. In addition, it facilitates the regular undercarriage cleaning operations and the spoils removal process.

Smallest swing radius

The short tail design with 1020 mm tail swing radius and a minimum rear protrusion from the tracks of just 240 mm allows the operator to concentrate on work in confined areas.

Two-post canopy

The two-post canopy with steel roof is compliant with ROPS (ISO 3471) and OPG (ISO 10262) standards. It provides excellent forward visibility without any obstacles.

ID key

The motor will not start if the key is not registered to the machine, reducing the risk of machine theft.



Secondary motor shutdown switch



Seat belt caution and neutral position detection system caution



ID key (starter key with registered ID)



Hose burst valves on boom and arm cylinders



Rear-view camera system (cab version)

Specifications

Electric system

System voltage	115 V
Battery	
Type	Komatsu Lithium-ion battery pack LFP (Lithium Iron Phosphate) technology
Capacity	35 kWh / 302 Ah
Run time*	approx. 3 h
Charging time (20 to 100%)*	approx. 1.8 h

* Depending on application, temperature, etc

Electric motor

Type	3 phase AC permanent magnet motor
Motor power	
at rated motor speed	17.4 kW
max. torque / motor speed	88.5 N·m / 1320 rpm

Battery charger

Type	External DC charger
Input current	37 A
Input voltage	400 V
Input plug type	CEE 63 A
Weight	125 kg (incl. 4 m cable)

Hydraulic system

Type	Komatsu CLSS
Main pump	2 × variable displacement pump
Max. pump flow	35.7 × 2 + 18.7 + 9.9 l/min
Max. operating pressure	26.0 MPa (260 bar)
Hydraulic motors	
Travel	2 × variable displacement motor
Swing	1 × fixed displacement motor
Hydraulic cylinders (bore × stroke)	
Boom	85 × 550 mm
Arm	75 × 495 mm
Bucket	65 × 490 mm
Boom swing	80 × 500 mm
Blade	85 × 135 mm
Bucket digging force (ISO 6015)	2942 daN (3000 kg)
Arm crowd force (ISO 6015)	1491 daN (1520 kg)

Swing system

The rotation is operated by means of an orbital hydraulic motor. Single ball-bearing ring with internal, induction hardened toothring. Centralised lubrication of the unit.

Swing speed	9.0 rpm
-------------	---------

Drives and brakes

Steering control	2 levers with pedals giving full independent control of each track
Drive method	Hydrostatic
Hydraulic motors	2 × axial piston motor
Reduction system	Planetary gear
Max. travel speeds Lo / Hi	2.6 / 4.6 km/h
Max. drawbar pull	3335 daN (3400 kgf)

Undercarriage

Construction	X-frame centre section with box section track frames
Track rollers (each side)	4
Carrier rollers (each side)	1
Shoe width	300 mm
Ground pressure (standard)	0.34 kg/cm ²

Environment

Engine emissions	Zero
Noise levels (canopy)	
LwA external	92 dB(A) (2000/14/EC Stage II)
LpA operator ear	75 dB(A) (ISO 6396 dynamic test)
Vibration levels (EN 12096:1997)	
Hand/arm	≤ 2.5 m/s ² (uncertainty K = 0.58 m/s ²)
Body	≤ 0.5 m/s ² (uncertainty K = 0.22 m/s ²)

Operating weight (appr.)

Canopy	3640 kg
Cab	3820 kg

Operating weight, including rubber shoes, specified work equipment, driver and standard equipment.

Service refill capacities

Hydraulic system	34 l
------------------	------

Machine dimensions

		Canopy	Cab
Boom length	mm	2285	
Arm length	mm	1610	
A Overall length	mm	4600	
B Overall height	mm	2520	2590
C Overall width	mm	1560	
D Clearance under revolving frame	mm	545	
E Ground clearance	mm	305	
F Tail swing radius	mm	1020	
G Track length on ground	mm	1650	
H Track length	mm	2105	
I Track gauge	mm	1250	
J Shoe width	mm	300	
K Overall width of upper structure	mm	1515	
L Distance, swing center to rear end	mm	1050	
M/N Boom swing angle	°	80/50	
O Boom offset LH	mm	580	
P Boom offset RH	mm	845	

Blade

Type	Electro-welded, single unit structure
Width × height	1560 × 365 mm
Blade, max. lifting height	360 mm
Blade, max. digging depth	315 mm

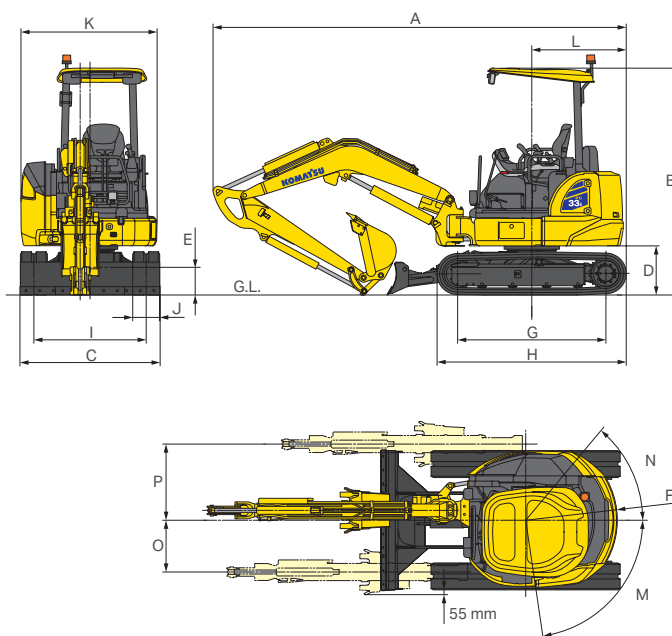

Battery charger dimensions



Working range

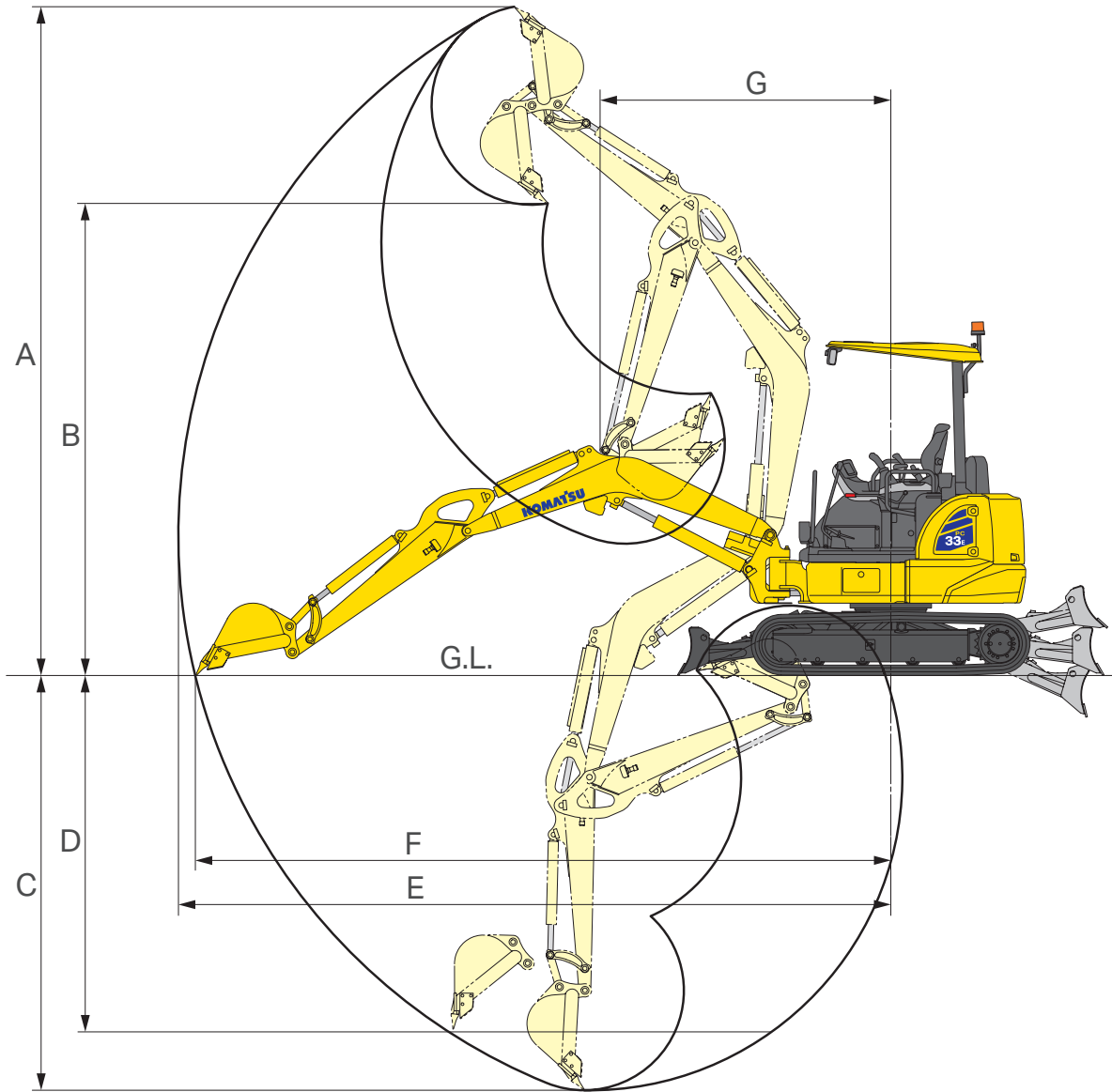

Working range

Boom length	mm	2285
Arm length	mm	1610
A Max. digging height	mm	5070
B Max. dumping height	mm	3580
C Max. digging depth	mm	3130
D Max. vertical wall digging depth	mm	2770
E Max. digging reach	mm	5390
F Max. digging reach at ground level	mm	5215
G Min. swing radius	mm	2190
Min. swing radius at boom swing	mm	1665

Lifting capacity

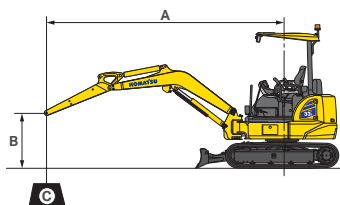

A – Reach from swing center

B – Bucket hook height









C – Lifting capacities

 – Rating over front









 – Rating over side

 – Rating at maximum reach

With canopy, 300 mm rubber shoes, no bucket, blade up

Arm length	A				4.0 m		3.0 m		2.0 m	
	B									
1610 mm	3.0 m	kg	540	440	560	460				
	2.0 m	kg	450	370	550	450	*820	700		
	1.0 m	kg	430	350	530	430	810	650		
	0 m	kg	440	360	520	420	780	620	1460	1100

With cab, 300 mm rubber shoes, no bucket, blade up

Arm length	A				4.0 m		3.0 m		2.0 m	
	B									
1610 mm	3.0 m	kg	550	450	570	460				
	2.0 m	kg	470	380	560	460	*820	710		
	1.0 m	kg	440	350	550	440	840	660		
	0 m	kg	450	370	530	430	800	630	1510	1120

Ratings are based on ISO standard 10567. Rated loads do not exceed 87% of hydraulic lift capacity or 75% of tipping load. Excavators used in object handling operations must comply with the related local regulations and must be equipped with hose burst valves (boom & arm) and an overload warning device in compliance with EN474-5.

- The values marked with an asterisk (*) are limited by the hydraulic capacities.
- Calculations are based on the machine resting on a uniform and firm surface.



Standard and optional equipment

Motor

3 phase AC permanent magnet motor	●
Auto-deceleration function	●
Auto idle stop	●
Motor control dial	●

Battery system

Lithium-ion battery 35 kWh / 302 Ah	●
External DC charger (400 V)	●
Charger cable (4 m)	●

Hydraulic system

8-working mode selection system; power mode, economy mode 0 & mode 1, breaker mode, attachment power and attachment economy mode 0 & mode 1, and lifting mode	●
Adjustable PPC wrist control levers for arm, boom, bucket and swing, with proportional control for attachments	●
PPC control lever and pedals for steering and travel	●
Hydraulic line for hammer and for 2-way equipment up to boom and arm (HCU-A) (canopy version)	●
2nd auxiliary hydraulic circuit (HCU-C) (cab version)	●
Automatic two-speed travel control	●
Relief valves on service spool	●
Preparation for hydraulic quick-coupler single effect (cab version)	●

Undercarriage

300 mm rubber shoes	●
---------------------	---

Cabin

ROPS (ISO 3471) / OPG (ISO 10262) level 1 tilting cab with heating, skylight, pull-up type front window with locking device, lower window, windscreen-wiper, floor mat, sun roller blind	●
Adjustable high comfort air suspension seat with retractable seat belt	●
Monitor panel 3.5" colour display	●
12 Volt power supply	●
Beverage holder and magazine rack	●

Canopy

ROPS (ISO 3471) / OPG (ISO 10262) level 1 canopy with floor mat	●
Adjustable air-suspension seat with retractable seat belt	●
Monitor panel 3.5" colour display	●
12 Volt power supply	●
Beverage holder	●

Service and maintenance

Multi-function video compatible colour monitor with Equipment Management and Monitoring System (EMMS) and efficiency guidance	●
Battery main switch	●
Komtrax – Komatsu wireless monitoring system (4G)	●

Safety equipment

Electric horn	●
Hose burst valves on boom and arm cylinders	●
Motor shutdown secondary switch	●
Neutral position detection system	●
Overload warning device	●
Rear-view mirrors (left and right side)	●
Seat belt caution indicator	●
Anti-slip cabin access	●
Mountings for OPG Level 1 front guard	●
Travel acoustic alarm	●
ID key (starter key with registered ID)	●
Rear-view camera system (cab version)	●
Rotating beacon	●

LED lighting system

Working light on boom	●
Working light on lower part of canopy	●
Two front working lights on cab	●
Rear working light on cab	●

Work equipment

Boom	●
Blade	●
Boom cylinder protection guard	●
Protection for boom and arm safety valve	●
1610 mm digging arm	●
Bucket linkage with lifting eye	○

Other equipment

Standard colour scheme and decals	●
Parts book and operator manual	●
Change-over valve on bucket cylinder for clamshell bucket utilization	○
Special waxing	○

Further equipment on request

- standard equipment
- optional equipment



A wide range of buckets and attachments is available. Your Komatsu distributor is ready to assist you with the selection of suitable options.

This specification sheet may contain attachments and optional equipment that are not available in your area. Please consult your local Komatsu distributor for those items you may require. Materials and specifications are subject to change without notice.

Your Komatsu partner:

KOMATSU

[komatsu.eu](https://www.komatsu.eu)

