

KOMATSU

PC138US-11



Hydraulic excavator

Engine power
72.6 kW / 97.3 HP @ 2050 rpm

Operating weight
14080-15800 kg

Bucket capacity
max. 0.72 m³

High versatility, low fuel-consumption and
safe performance in tight spaces



Engine power
72.6 kW / 97.3 HP @ 2050 rpm

Operating weight
14080-15800 kg

Bucket capacity
max. 0.72 m³

Powerful and environmentally friendly

- EU Stage V engine
- Komatsu diesel particulate filter (KDPF)
- Adjustable idle shutdown
- Komatsu fuel-saving technology

Total versatility

- Ideal for a wide range of applications
- Short tail swing and exceptional stability
- 6 working modes
- Wide choice of options



First-class comfort

- Fully air-suspended operator station
- Low-noise design
- Widescreen monitor

Safety first

- Komatsu SpaceCab™
- KomVision surround view system
- KomVision 4th camera option
- Neutral position detection system

Komtrax

- Komatsu Wireless Monitoring System
- 4G mobile communications
- Integrated communication antenna
- Increased operational data and reports



A maintenance program
for Komatsu customers

PC138US-11



Higher productivity

The PC138US-11 is quick and precise. It features a powerful Komatsu EU Stage V engine, Komatsu's Closed Center Load Sensing (CLSS) hydraulic system and first-class Komatsu comfort to provide a fast response and unrivalled productivity for its class.

Komatsu fuel-saving technology

With enhanced engine management the PC138US-11 is optimised for low fuel consumption. The variable speed matching of the engine and hydraulic pumps guarantee efficiency and precision during single and combined movements.

Adjustable idle shutdown

The Komatsu auto idle shutdown automatically turns off the engine after it idles for a set period of time. This feature can easily be programmed from 5 to 60 minutes, to reduce unnecessary fuel consumption and exhaust emissions, and to lower operating costs. An Eco-gauge and the Eco guidance tips on the cab monitor further encourage efficient operations.

Powerful and environmentally friendly

Komatsu EU Stage V

The Komatsu EU Stage V engine is productive, dependable and efficient. With ultra-low emissions, it provides a lower environmental impact and a superior performance to help reduce operating costs and lets the operator work in complete peace of mind.

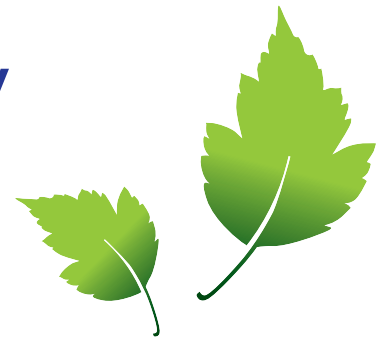

Heavy-duty aftertreatment

The aftertreatment system combines a Komatsu Diesel Particulate Filter (KDPF) and Selective Catalytic Reduction (SCR). The SCR injects the correct amount of AdBlue® into the system at the proper rate to break down NOx into water (H₂O) and non-toxic nitrogen gas (N₂). NOx emissions are reduced by 80% vs. EU Stage IIIB engines.

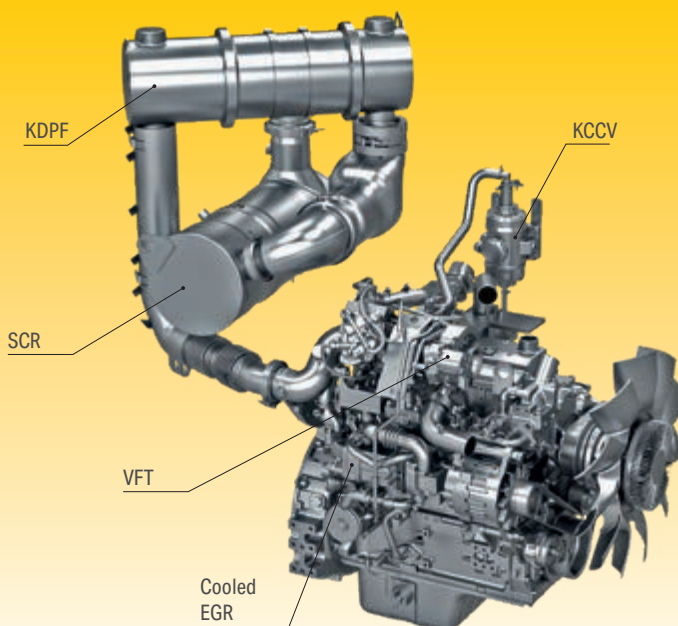
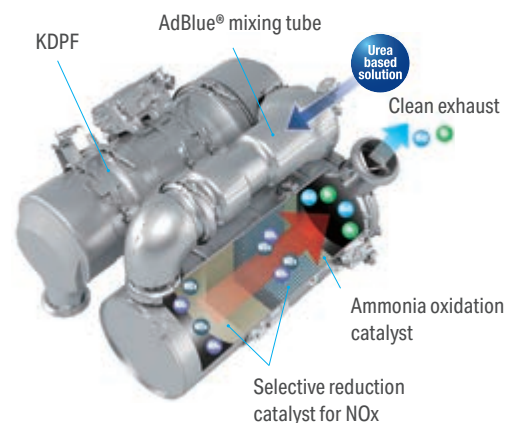

High-Pressure Common Rail (HPCR)

To achieve complete fuel burn and lower exhaust emissions, the heavy-duty High-Pressure Common Rail fuel injection system is computer controlled to deliver a precise quantity of pressurised fuel into the redesigned engine combustion chamber by multiple injections.

Exhaust Gas Recirculation (EGR)

Cooled EGR is a technology well-proven in current Komatsu engines. The increased capacity of the EGR cooler now ensures very low NOx emissions and a better engine performance.

Komatsu Closed Crankcase Ventilation (KCCV)

Crankcase emissions (blow-by gas) are passed through a CCV filter. The oil mist trapped in the filter is returned back to the crankcase while the filtered gas is returned to the air intake.

Variable Flow Turbocharger (VFT)

Varies the intake airflow. The wheel speed of the exhaust turbine is controlled by a valve for optimum air flow to the engine combustion chamber, under any load or speed conditions. The exhaust gas is cleaner, with no reduction in power or performance.

PC138US-11

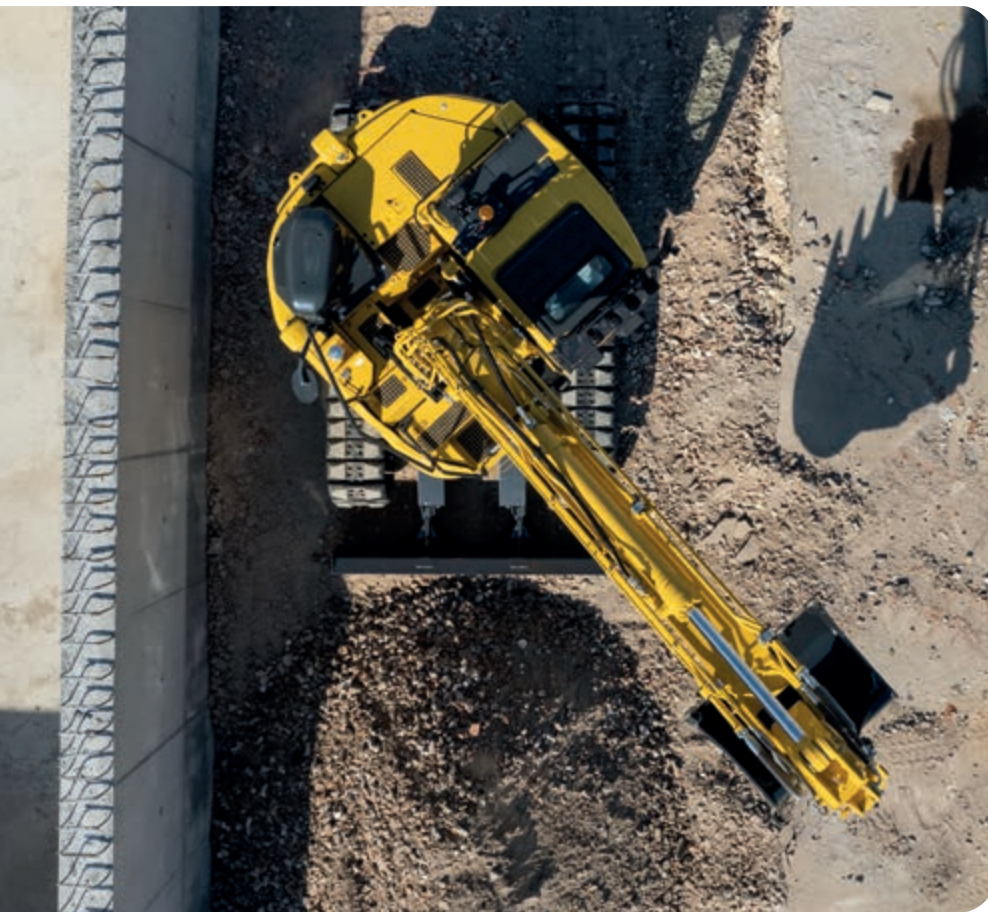

Safe operation in confined areas

The PC138US-11 has a rounded profile with minimal protrusions at both the front and the rear. Its ultra-short tail swing radius is perfect for work in tight spaces, particularly in urban areas, or for road construction, logging and demolition. Thanks to optimised packaging, the PC138US-11 is exceptionally stable. Coupled with the machine's wide working range, this stability makes it ideal for any work requiring long reach, such as demolition jobs and slope cutting.

Short tail swing radius

1,48 m – Because the tail of the PC138US-11 is more compact than conventional models, the PC138US-11 reduces the operator's need to check behind him for movement.

Short implement swing radius

1,98 m – Boom raising angle of the PC138US-11 is larger than on a conventional profile excavator, while front implement protrusion is lessened.

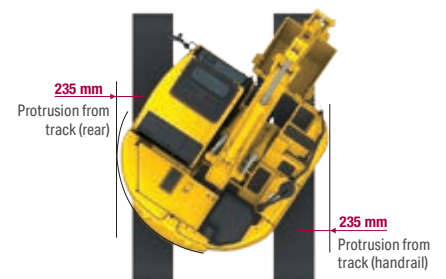
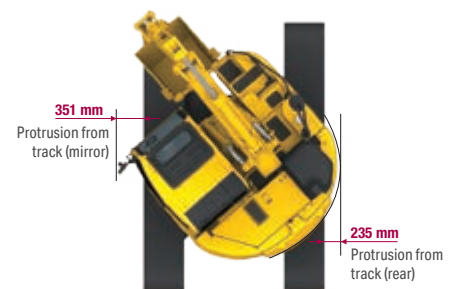

Safety first

Optimal jobsite safety

Safety features on the Komatsu PC138US-11 comply with the latest industry standards and work in synergy to minimise risks to people in and around the machine. A neutral detection system for travel and work equipment levers increase jobsite safety, along with a seat belt caution indicator and an audible travel alarm. Highly durable anti-slip plates – with additional high friction covering – maintain long term traction performance.



Safe maintenance

Thermal guards around high temperature areas of the engine, protected fan belt and pulleys, a pump/engine partition that prevents hydraulic oil from spraying onto the engine, and exceptionally sturdy handrails: in Komatsu tradition, the highest safety level is provided for a fast and smooth maintenance.



Komatsu SpaceCab™

The ROPS cab has a tubular steel frame and provides high shock absorbency, impact resistance and durability. The seat belt is well designed to keep the operator in the safety zone of the cab in the event of a rollover. Optionally the cab can be fitted with a Falling Object Protective System (FOPS) with openable front guard.



KomVision

KomVision machine visibility gives the operator a constant clear view of the safety zone around the machine. This allows the operator to focus on the work at hand even in low light conditions. With KomVision, various camera view options are available whilst maintaining constant "birdview" from above the machine.

Total versatility

Ideal for a wide range of applications

Powerful and precise, the Komatsu PC138US-11 is equipped to efficiently carry out any task your business requires. On big sites or small, for digging, trenching, landscaping or site preparation, the Komatsu original equipment hydraulic system always ensures maximum productivity and control.

6 working modes

Power, Lifting, Breaker, Economy, Attachment Power and Attachment Economy modes are all available, ensuring that the PC138US-11 delivers the power you need with minimised fuel usage. The Economy mode can be adjusted for an ideal balance between power and economy to match your work. The oil flow delivered to hydraulic attachments is adjustable directly on the class-leading wide screen monitor panel.



Versatility at your fingertips: select the perfect setting for each job

Built-in versatility

A standard fit additional hydraulic circuit, controlled by a sliding joystick push button and a floor mounted pedal, gives the PC138US-11 excellent versatility. Ten attachment memory settings are provided, with individually definable names. In combination with the standard-fit hydraulic quick coupler power circuit, changing working style is now even simpler. A second auxiliary hydraulic line is available for attachments which require extra hydraulic actuation.

A wide choice of options

With many options available – such as road-liner track shoes, dozer blade, two-piece boom or super long front – you can configure the PC138US-11 to match specific demands for transport, working envelope or duty.



Komatsu Integrated Attachment Control (KIAC) for up to 15 tool presets for oil flow and pressure (option)





First-class comfort

Increased comfort

In the wide Komatsu SpaceCab™, a standard air-suspended high-back seat, heated for improved comfort and with fully adjustable armrests, is the centre of a comfortable and low-fatigue working environment. High visibility and ergonomic controls further assist to maximise the operator's productivity.

Perfect operator convenience

In addition to the standard radio, the PC138US-11 has an auxiliary input for connecting external devices and play music through the cab speakers. Two 12-volt power ports are also incorporated in the cab. Proportional controls are fitted as standard for safe and precise operation of attachments.

Low-noise design

Komatsu crawler excavators have very low external noise levels and are especially well-suited for work in confined spaces or urban areas. The optimal usage of sound insulation and of sound absorbing materials helps to make noise levels inside the cab comparable to those of an executive car.



Convenient, ergonomic and precise control: joysticks with proportional control button for attachments



Auxiliary input (MP3 jack) & cup holder



12 V and 24 V power supply

Easy maintenance

Komatsu Care

Komatsu Care is a maintenance program that comes as standard with your new Komatsu machine. It covers factory-scheduled maintenance, performed with Komatsu Genuine parts by Komatsu-trained technicians. It also offers extended coverage of the Komatsu Diesel Particulate Filter (KDPF) and of the Selective Catalytic Reduction (SCR). Please contact your local Komatsu distributor for terms and conditions.

Optimum maintenance layout

Effortless access to engine-related maintenance items such as oil filter, oil dipstick, coolant reserve tank, fuel filter, and air cleaner.

Long-life oil filters

The Komatsu Genuine hydraulic oil filter uses high-performance filtering material for long replacement intervals, which significantly reduces maintenance costs.

Flexible warranty

When you purchase Komatsu equipment, you gain access to a broad range of programmes and services that have been designed to help you get the most from your investment. For example, Komatsu's Flexible Warranty Programme provides a range of extended warranty options on the machine and its components. These can be chosen to meet your individual needs and activities. This programme is designed to help reduce total operating costs.

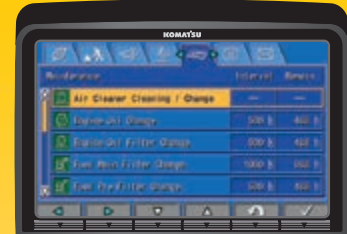

Basic maintenance screen



Aftertreatment device regeneration screen for the KDPF



For simple access, the AdBlue® tank is installed on the front stairway.





An evolutionary interface

Helpful information is now easier than ever to find and understand with the upgraded monitor interface. An optimal main screen for the ongoing work can be selected simply by pressing the F3 key.

Lower operating costs

Komatsu ICT contributes to the reduction of operating costs by assisting to comfortably and efficiently manage operations. It raises the level of customer satisfaction and the competitive edge of our products.

Widescreen monitor

Installed with a choice of 26 languages, the widescreen monitor with simple switches and multifunction keys gives fingertip access to a large range of functions and operating info.



Eco-gauge, Eco guidance and fuel consumption gauge



Fuel consumption history



ECO guidance record

Information & communication technology



Knowledge

You get quick answers to basic and critical questions about your machines – what they're doing, when they did it, where they're located, how they can be used more efficiently and when they need to be serviced. Performance data is relayed by wireless communication technology (satellite, GPRS or 4G depending on model) from the machine to a computer and to the local Komatsu distributor – who's readily available for expert analysis and feedback.

Convenience

Komtrax enables convenient fleet management on the web, wherever you are. Data is analysed and packaged specifically for effortless and intuitive viewing in maps, lists, graphs and charts. You can foresee eventual maintenance issues and required spare parts, and troubleshoot a problem before Komatsu technicians arrive on site.



The way to higher productivity

Komtrax uses the latest wireless monitoring technology. Compatible on PC, smartphone or tablet, it delivers insightful and cost saving information about your fleet and equipment, and offers a wealth of information to facilitate peak machine performance. By creating a tightly integrated web of support it allows proactive and preventive maintenance and helps to efficiently run a business.

Power

The detailed information that Komtrax puts at your fingertips 24 hours a day, 7 days a week gives the power to make better daily and long-term strategic decisions – at no extra cost. Problems can be anticipated, maintenance schedules customised, downtime minimised and machines kept where they belong: working on the jobsite.



Specifications PC138US-11E0

Engine

Model	Komatsu SAA4D95LE-7
Type	Common rail direct injection, water-cooled, emissionised, turbocharged, after-cooled diesel
Engine power	
at rated engine speed	2050 rpm
ISO 14396	72.6 kW / 97.3 HP
ISO 9249 (net engine power)	72.5 kW / 97.2 HP
No. of cylinders	4
Bore × stroke	95 × 115 mm
Displacement	3.26 l
Air filter type	Dry, double element type air cleaner with dust indicator and auto-dust evacuator
Cooling	Suction type cooling fan with radiator fly screen
Fuel	Diesel fuel, conforming to EN590 Class 2/ Grade D. Paraffinic fuel capability (HVO, GTL, BTL), conforming to EN15940:2016

Drives and brakes

Steering control	2 levers with pedals giving full independent control of each track
Drive method	Hydrostatic
Gradeability	70%, 35°
Max. travel speeds	
Lo / Hi	2.9 / 5.1 km/h
Maximum drawbar pull	12500 kg
Brake system	Hydraulically operated discs in each travel motor

Undercarriage

Construction	X-frame centre section with box section track frames
Track assembly	
Type	Fully sealed
Shoes (each side)	43
Rollers	
Track rollers (each side)	7
Carrier rollers (each side)	1

Hydraulic system

Type	HydrauMind. Closed-centre system with load sensing and pressure compensation valves
Additional circuit	1 additional circuit with proportional control can be installed
Main pump	1 variable displacement piston pump supplying boom, arm, bucket, swing and travel circuits
Maximum pump flow	242 l/min
Relief valve settings	
Implement	355 kg/cm ²
Travel	355 kg/cm ²
Swing	265 kg/cm ²
Pilot circuit	34 kg/cm ²

Swing system

Type	Axial piston motor driving through planetary double reduction gearbox
Swing lock	Electrically actuated wet multidisc brake integrated into swing motor
Swing speed	0 - 11 rpm
Swing torque	33 kNm

Service refill capacities

Fuel tank	200 l
Radiator	16.1 l
Engine oil	11.5 l
Swing drive	2.5 l
Hydraulic tank	69 l
Final drive (each side)	2.1 l
AdBlue® tank	21.1 l

Environment

Engine emissions	Fully complies with EU Stage V exhaust emission regulations
Noise levels	
LwA external	99 dB(A) (2000/14/EC Stage II)
LpA operator ear	72 dB(A) (ISO 6396 dynamic test)
Vibration levels (EN 12096:1997)	
Hand/arm	≤ 2.5 m/s ² (uncertainty K = 0.63 m/s ²)
Body	≤ 0.5 m/s ² (uncertainty K = 0.25 m/s ²)
Contains fluorinated greenhouse gas HFC-134a (GWP 1430). Quantity of gas 0.8 kg; CO ₂ equivalent 1.14 t	

Operating weight (appr.)

Triple grouser shoes	Mono boom		Two-piece boom	
	Operating weight	Ground pressure	Operating weight	Ground pressure
500 mm	14080 kg	0.49 kg/cm ²	15180 kg	0.50 kg/cm ²
600 mm	14250 kg	0.42 kg/cm ²	15620 kg	0.44 kg/cm ²
700 mm	14430 kg	0.35 kg/cm ²	15800 kg	0.38 kg/cm ²
500 mm road liner	14190 kg	0.50 kg/cm ²	15570 kg	0.50 kg/cm ²

Operating weight, including specified work equipment, 2,5 m arm, 470 kg bucket, operator, lubricant, coolant, full fuel tank and the standard equipment.
Additional weight with blade: + 800 kg

Machine dimensions

D Overall width	2490 mm
E Overall height (To top of cab)*	3150 mm
F Ground clearance, counterweight	900 mm
G Minimum ground clearance	395 mm
H Tail swing radius	1480 mm
I Length of track on ground	2880 mm
J Track length	3610 mm
K Track gauge	1990 mm
L Width of crawler	2490 mm
M Shoe width	500 mm
N Grouser height	20 mm
O Machine tail height	2140 mm
P Overall width of upper structure	2490 mm
Q Distance, swing center to rear end	1480 mm
S Distance, swing center to blade	2500 mm
T Blade, max. lifting height	470 mm
U Height of blade	590 mm
V Blade, max. digging depth	525 mm

* Including grouser height

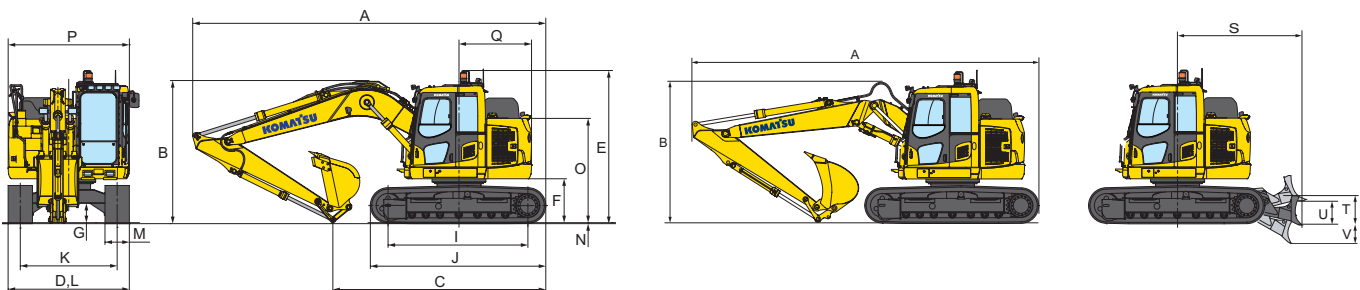

Transport dimensions

	Mono boom		Two-piece Boom
Arm length	2500 mm	3000 mm	2500 mm
A Transport length	7260 mm	7160 mm	8100 mm
B Overall height (to top of boom)	2950 mm	3210 mm	-
C Length on ground (transport)	4400 mm	4290 mm	4730 mm

Working range

Mono boom

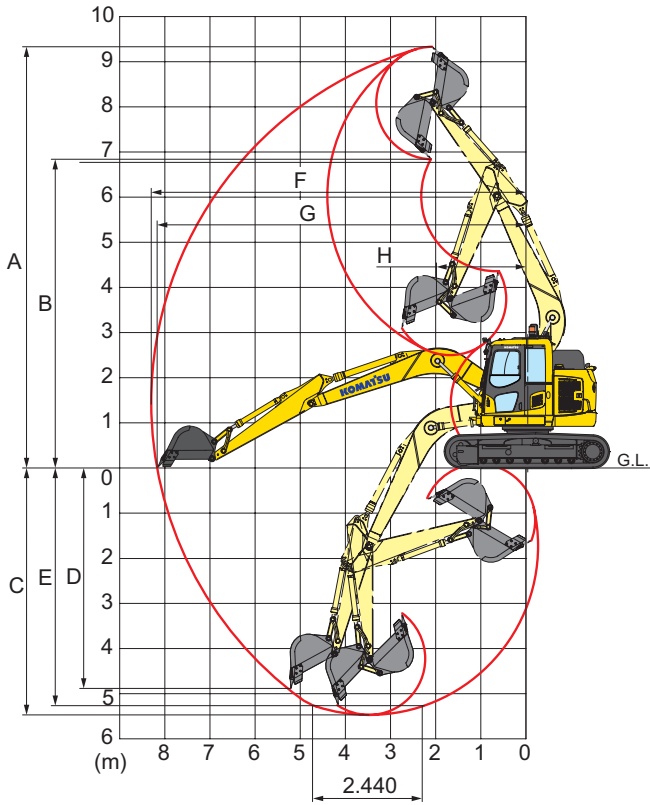

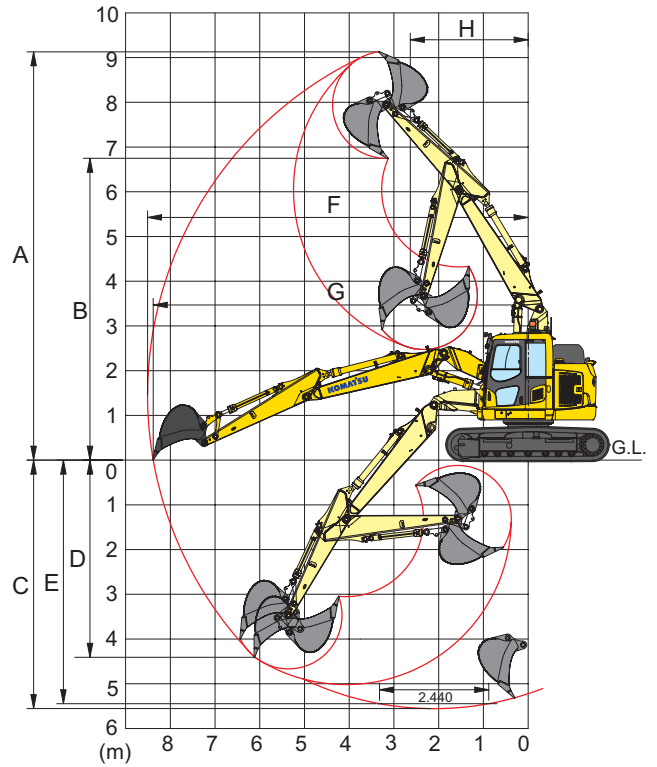

Two-piece boom



Working range

	Mono boom		Two-piece boom
Arm length	2500 mm	3000 mm	2500 mm
A Max. digging height	9340 mm	9700 mm	9130 mm
B Max. dumping height	6840 mm	7350 mm	6750 mm
C Max. digging depth	5480 mm	5900 mm	5680 mm
D Max. vertical wall digging depth	4900 mm	5340 mm	4400 mm
E Max. digging depth of cut for 2,44 m level	5265 mm	5715 mm	5570 mm
F Max. digging reach	8300 mm	8720 mm	8510 mm
G Max. digging reach at ground level	8180 mm	8600 mm	8380 mm
H Min. swing radius	1980 mm	2265 mm	2500 mm
Bucket digging force (ISO)	9316 daN	9316 daN	9140 daN
Arm crowd force (ISO)	6178 daN	5590 daN	6060 daN













Lifting capacity

-  - Rating over front
-  - Rating over side
-  - Rating at maximum reach







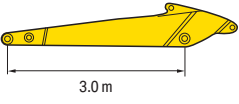
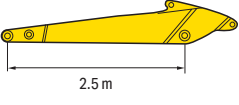





- A** - Reach from swing center
- B** - Bucket hook height
- C** - Lifting capacities, including bucket (400 kg), bucket linkage and bucket cylinder

When removing bucket, linkage or cylinder, lifting capacities can be increased by their respective weights
With 500 mm shoes

Mono boom

Arm length	A				7.0 m		6.0 m		4.5 m		3.0 m		1.5 m	
	B													
 <p>3.0 m</p>	6.0 m	kg	*1340	*1340			*1870	*1870	*2670	*2670				
	4.5 m	kg	*1250	*1250	*1600	1430	*2680	1950	*2840	*2840				
	3.0 m	kg	*1250	1170	2250	1400	2950	1870	*3760	3090	*3740	*3740		
	1.5 m	kg	*1330	1090	2180	1340	2830	1760	4580	2840	*7560	5440		
	0.0 m	kg	*1500	1100	2120	1280	2720	1660	4330	2620	*6480	4930		
	-1.5 m	kg	*1810	1200	2080	1250	2650	1600	4200	2500	*6220	4760	*3840	*3840
	-3.0 m	kg	2460	1490			2660	1600	4180	2490	*6480	4780	*5760	*5760
-4.5 m	kg	*2920	2290						*3500	2590	*5500	4950		
 <p>2.5 m</p>	6.0 m	kg	*1650	*1650					*3100	*3100				
	4.5 m	kg	*1540	*1540			*2850	1920	*3570	3210				
	3.0 m	kg	*1550	1340	*1970	1390	2930	1860	*4360	3040	*5880	*5880		
	1.5 m	kg	*1660	1250	2180	1340	2830	1770	4540	2820	*7430	5310		
	0.0 m	kg	*1910	1260	2140	1300	2740	1680	4340	2640	*6090	4940		
	-1.5 m	kg	2310	1410			2700	1640	4250	2560	*6070	4860	*4370	*4370
	-3.0 m	kg	2940	1800					4270	2570	*6540	4920	*5750	*5750
-4.5 m	kg													

Two-piece boom

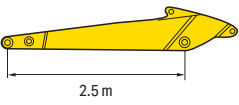
Arm length	A				7.0 m		6.0 m		4.5 m		3.0 m		1.5 m	
	B													
 <p>2.5 m</p>	7.5 m	kg	*2500	*2500										
	6.0 m	kg	*2050	*2050					*3100	*3100				
	4.5 m	kg	*1900	1550			2750	2050	*3350	*3350				
	3.0 m	kg	1800	1300			2700	1950	*4100	3250	*5850	*5850		
	1.5 m	kg	1700	1200	1700	1200	2550	1850	4200	3000				
	0.0 m	kg	1700	1200	1700	1200	2450	1750	4000	2800				
	-1.5 m	kg	1900	1350			2400	1700	3900	2700	*7500	4600		
	-3.0 m	kg	2400	1700			2450	1700	3900	2700	*7450	5300		
-4.5 m	kg													

* Load is limited by hydraulic capacity rather than tipping.
Ratings are based on SAE Standard No. J1097.
Rated loads do not exceed 87% of hydraulic lift capacity or 75% of tipping load.

Standard and optional equipment

Engine

Komatsu SAA4D95LE-7 turbocharged common rail direct injection diesel engine	●
EU Stage V compliant	●
Automatic engine warm-up system	●
Engine overheat prevention system	●
Fuel control dial	●
Auto-deceleration function	●
Adjustable idle shutdown	●
Engine key stop	●
Engine ignition can be password secured on request	●
Alternator 24 V / 85 A	●
Starter motor 24 V / 4.5 kW	●
Batteries 2 × 12 V / 72-95 Ah	●

Hydraulic system

Electronic closed-centre load sensing (E-CLSS) hydraulic system (HydraMind)	●
Pump and engine mutual control (PEMC) system	●
6-working mode selection system; power mode, economy mode, breaker mode, attachment power and attachment economy mode, and lifting mode	●
Adjustable PPC wrist control levers for arm, boom, bucket and swing, with sliding proportional control for attachments and 3 auxiliary buttons	●
Prepared for hydraulic quick-coupler	●
One additional hydraulic circuit (HCU-C)	○
Komatsu Integrated Attachment Control (KIAC)	○

Undercarriage

Track frame under-guards	●
500 mm triple grouser shoes	●
600, 700 mm triple grouser shoes	○
500 mm road-liner (rubber) shoes	○
Additional track guiding guard	○

Drives and brakes

Hydrostatic, 2-speed travel system with automatic shift and planetary gear type final drives, and hydraulic travel and parking brakes	●
PPC control levers and pedals for steering and travel	●

Cabin

Reinforced safety SpaceCab™; highly pressurised and tightly sealed hyper viscous mounted cab with tinted safety glass windows, large roof window, pull-up type front window with locking device, removable lower window, front window wiper with intermittent feature, luggage shelf, floor mat	●
Heated, high back air suspension seat with lumbar support, console mounted height adjustable arm rests, and retractable seat belt	●
Automatic climate control system	●
12 / 24 Volt power supplies	●
Beverage holder and magazine rack	●
Hot and cool box	●
Radio	●
Auxiliary input (MP3 jack)	●
Lower wiper	●
Rain visor (not with OPG)	●
DAB+ digital radio	○
Foldable sun visor for roof window and front roller blinds	○

Service and maintenance

Automatic fuel line de-aeration	●
Double element type air cleaner with dust indicator and auto dust evacuator	●
Komtrax – Komatsu wireless monitoring system (4G)	●
Komatsu Care – a maintenance program for Komatsu customers	●
Multifunction video compatible colour monitor with Equipment Management and Monitoring System (EMMS) and efficiency guidance	●
Toolkit	●

Safety equipment

KomVision surround view system	●
Electric horn	●
Overload warning device	●
Audible travel alarm	●
Boom safety valves	●
Large handrails, rear-view mirrors	●
Battery main switch	●
ROPS (ISO 12117) - OPG (ISO 10262) Level 1	●
Neutral position detection system	●
Arm safety valve	●
Emergency engine stop switch	●
Seat belt caution indicator	●
Additional camera for KomVision surround view system	○
OPG Level II front guard (FOPS)	○

Lighting system

Working lights: 1 boom (l.h.), 1 cab (lower), 4 cab roof (front), 1 cab roof (rear), 1 counterweight (rear), beacon	●
LED working lights: 2 boom (l.h. & r.h.), 4 cab roof (front) (standard in combination with blade)	○

Work equipment

Mono boom	○
Two-piece boom	○
Super Long Front boom and arm	○
2.5 m arm	○
3.0 m arm (only with mono boom)	○
Dozer blade (with 500 or 600 mm shoes)	○
Komatsu buckets	○
Komatsu breakers	○

Other equipment

Remote greasing for swing circle and pins	●
Electric refuelling pump with automatic shut off function	●
Standard colour scheme and decals	●
Parts book and operator manual	●
Fuel preheater 5 kW	○
Additional counterweight 500 kg	○
Bucket linkage with lifting pin	○
Biodegradable oil for hydraulic system	○

Further equipment on request

- standard equipment
- optional equipment



KomVision surround view system (standard)



LED working lights (standard in combination with blade)



Dozer blade (option)



500 mm road-liner (rubber) shoes (option)

A wide range of buckets and attachments is available. Your Komatsu distributor is ready to assist you with the selection of suitable options.

This specification sheet may contain attachments and optional equipment that are not available in your area. Please consult your local Komatsu distributor for those items you may require.

Materials and specifications are subject to change without notice.

Your Komatsu partner:

KOMATSU

[komatsu.eu](https://www.komatsu.eu)

