

ROBIT® FOREPOLING PRODUCT CATALOGUE

RoX+ 76,1 systems
RoX+ 88,9 systems
RoX+ 101,6 systems
RoX+ 114,3 systems
RoX 139,7 systems
RoX+ 168,3 systems
RoX+ GFRP 76,1 systems



Robit

**FURTHER.
FASTER.**

ROBIT® FOREPOLING PRODUCT CATALOGUE

Copyright © 2019, Robit Plc

All rights reserved. No part of this catalogue may be reproduced or transmitted in any form or by any means, electronic or mechanical, including photocopying, recording, or by any information storage and retrieval system, without written permission from the publisher.

Trademarks

Robit is a trademark of Robit Plc

Publisher

Robit Plc

www.robitgroup.com

Printed: January 2019

Robit reserves all rights to any changes in the products and the specifications without prior notice.



Contents

ROBIT® FOREPOLING APPLICATION	4
ROBIT® FOREPOLING WORKFLOW	10
ROBIT® FOREPOLING PRODUCTS	16
ROBIT® PATENTED SPIRAL LOCKING SYSTEM	18
ROBIT® DIMENSIONS EXPLANATION	19
ROBIT® RoX IN BRIEF	20
ROBIT® RoX GFRP IN BRIEF	21
ROBIT® FOREPOLING DRILLING SYSTEMS	22
ROBIT® PRODUCT CODES & PART NUMBERS: RoX+	30
ROBIT® PRODUCT CODES & PART NUMBERS: RoX+ GFRP	31
ROBIT® RODS	32
ROBIT® DRILL TUBES	33

Robit® Forepoling Application



Forepoling

Forepoling, also known as tube umbrella, is an application used to strengthen tunnel roof in broken rock conditions. Drilling system consists of casing tubes which are drilled through the overburden as an umbrella and filled with grouting. Robit® Casing System allows easy driving of the casing tubes into the ground with low torque demand. In modern forepoling also fibreglass casings can be used for ultra-long facebolts.

Robit® Casing Systems mostly used in forepoling are RoX+ 88,9/8, RoX 114,3/10 and RoX 139,7/10.





1 Drilling the casings

2 Injecting the grouting

3 Excavating the tunnel

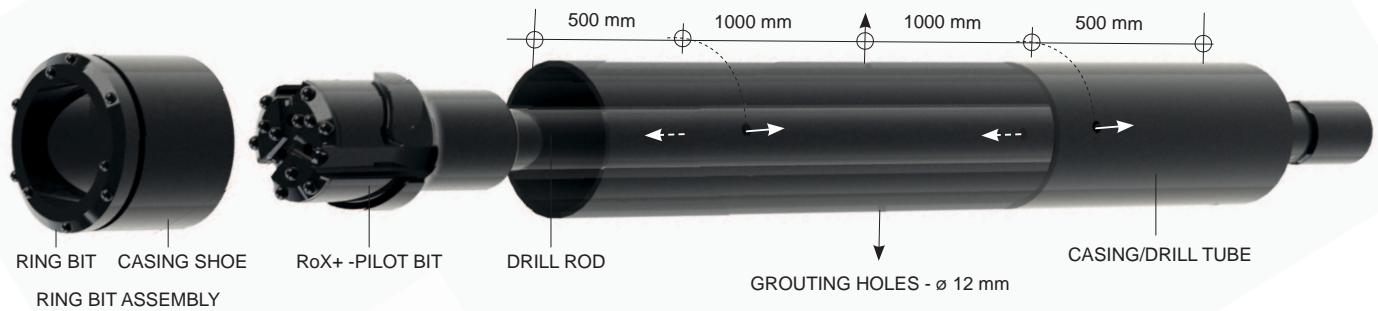

Casing tubes

- Typically one pile consist of several steel casings of 1,5 – 3 meters
- Connection by thread
- Injection valves for grouting
- Standard casing diameters: 88,9 - 114,3 - 139,7 - 168,3 mm

Preparation

- Robit® Ring Assembly is factory welded to the first casing (starter casing) by casing shoe
- Welding norm:
 - EN499: E42 6B 42 H5
 - AWS/ASME: SFA – 5.1/ E7018-1
 - DIN8529: ESY 42 76 Mn B

Required Equipment

- Almost any drill rig with standardized equipment can be used to drill tube umbrella
- Jumbo drill is commonly used
- A basket boom installed for the operators to connect casing or alternatively additional lifter
- Top hammer drilling/DTH

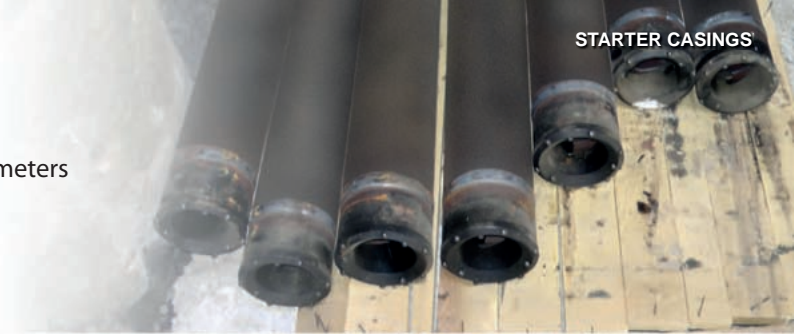

STARTER CASINGS



CASINGS, DRILL TUBES



GROUTING PLUG (END PLUG)

Typical design

- 20-40 casing tubes per advance
- Each pile 15 meters long, which gives about 12 meter tunnel advancement
- Tubes are inclined 3-5 degrees from tunnel advance direction
- Casing size and other specifications are determined by qualified tunnel engineers and geologists based on the soil conditions

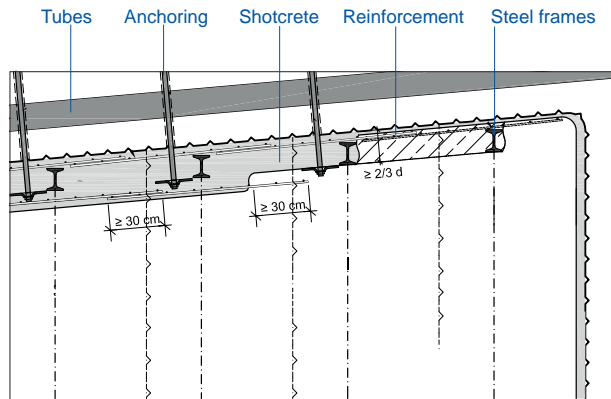

Det 1.

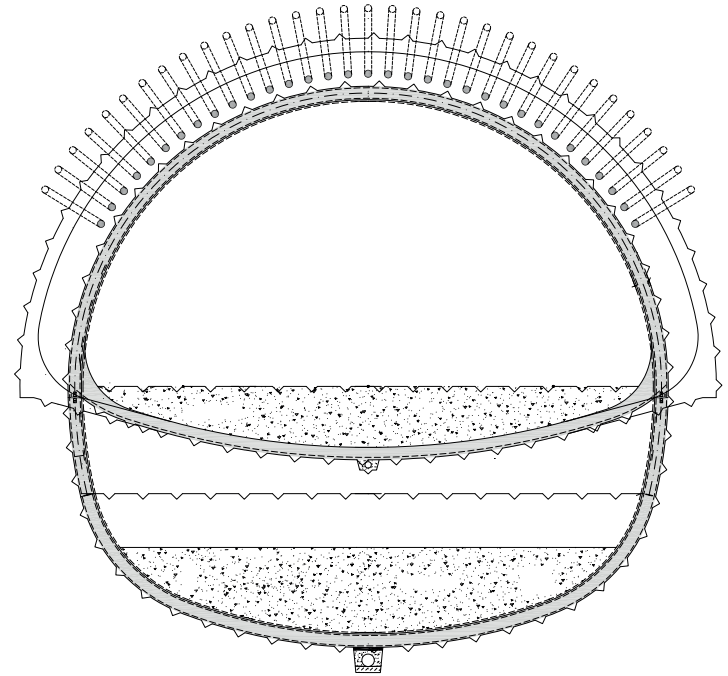

Cross section of single pipe forepoling

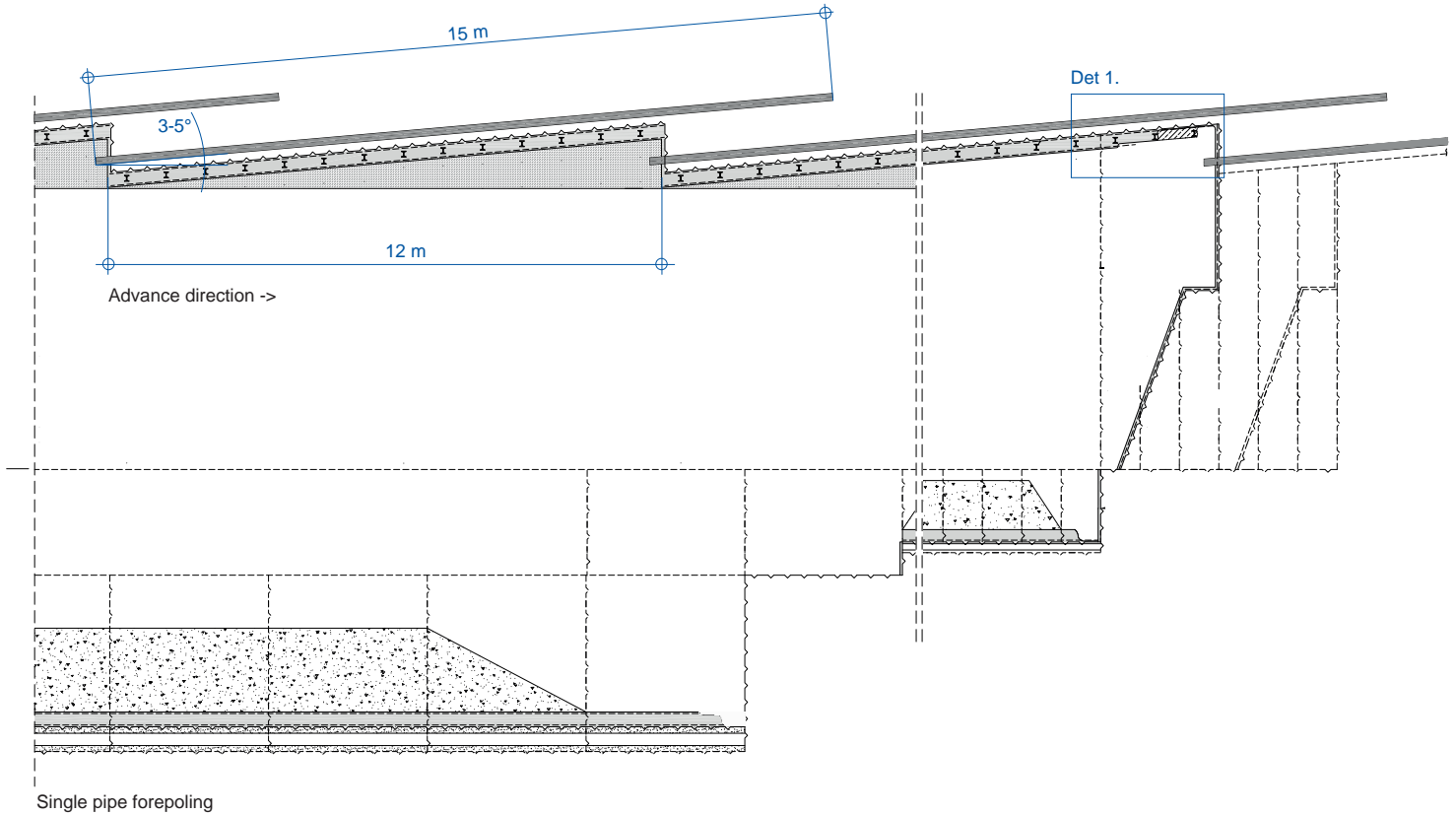

Robit® Forepoling Workflow

Robit® delivers full package of forepoling tools for drilling: pilots, ring bits, tubes, starter casings, drill rods, grouting plugs & shanks.

1 2
3 4

Threads must be inspected and if necessary greased before lifting them to jumbo's basket (you may check thread connection by using e.g. grouting plug's female end)

At the jobsite all tools must be stored in clean and safe place. No damages for casings or dirt for threads is allowed.

Thread the pilot to the extension rod.

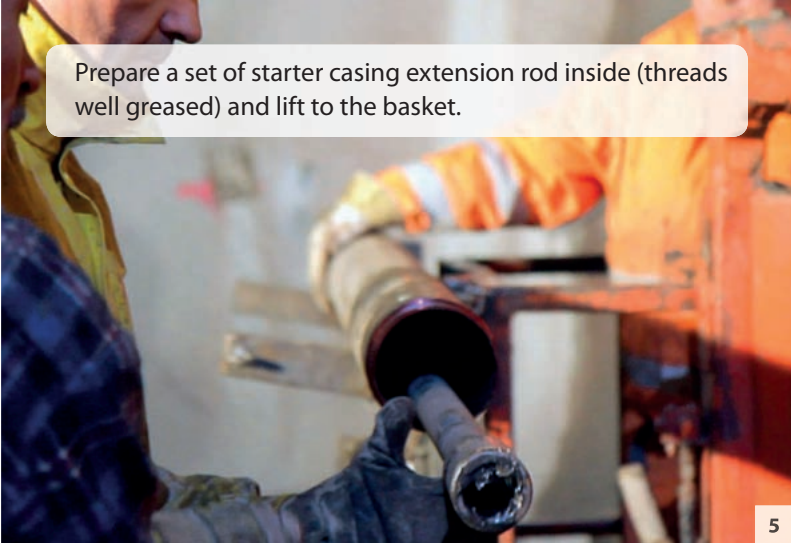

Prepare a set of starter casing extension rod inside (threads well greased) and lift to the basket.



Wash/clean jumbo's feed and boom from dirt.



Connect the extension rod to the shank.

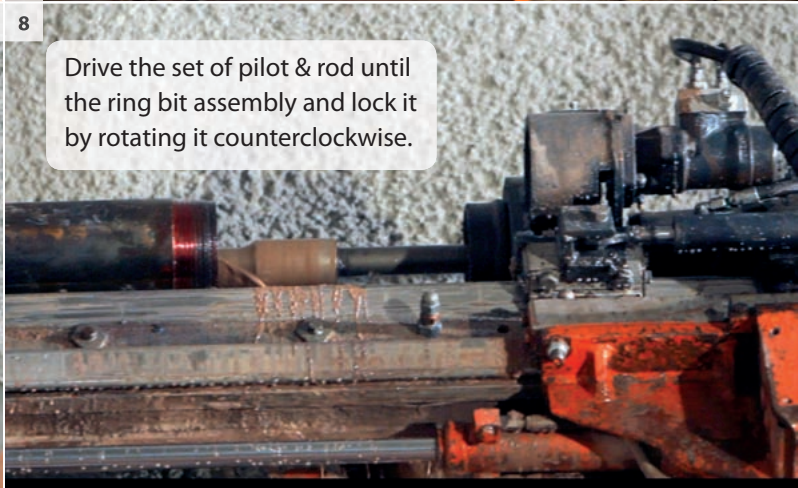

Drive the set of pilot & rod until the ring bit assembly and lock it by rotating it counterclockwise.

5 6
7 8

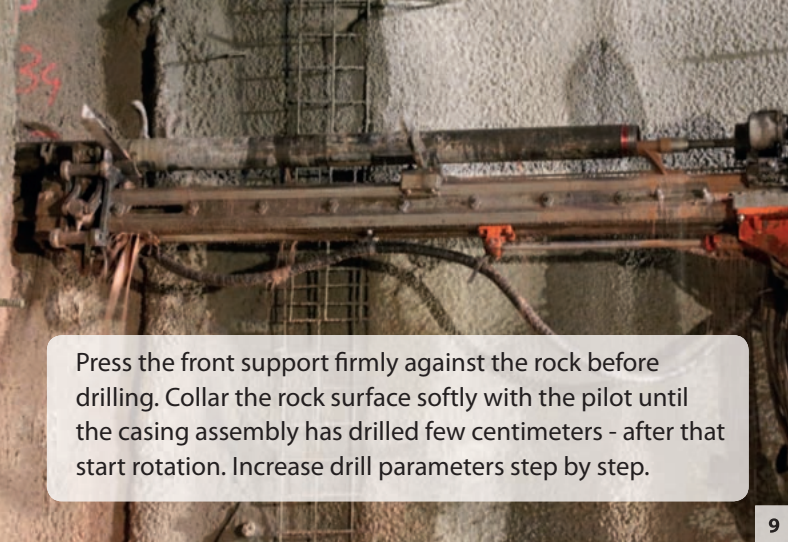

Press the front support firmly against the rock before drilling. Collar the rock surface softly with the pilot until the casing assembly has drilled few centimeters - after that start rotation. Increase drill parameters step by step.

9 10

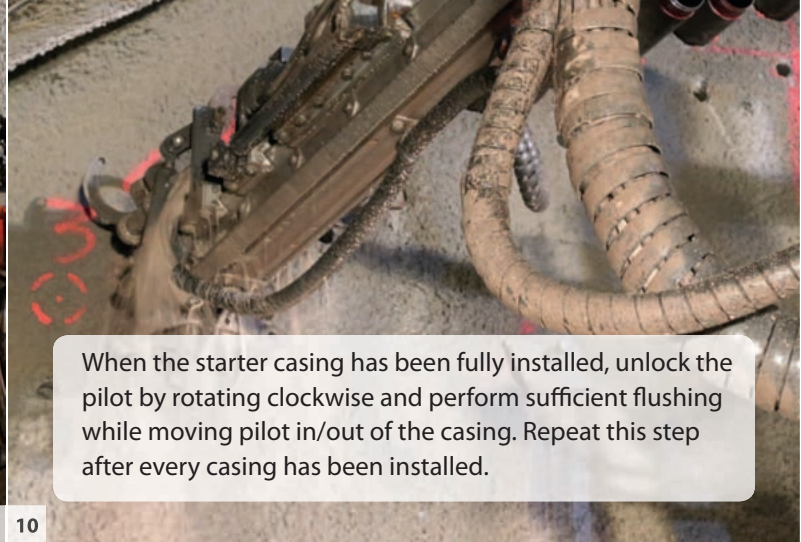

When the starter casing has been fully installed, unlock the pilot by rotating clockwise and perform sufficient flushing while moving pilot in/out of the casing. Repeat this step after every casing has been installed.

11 12

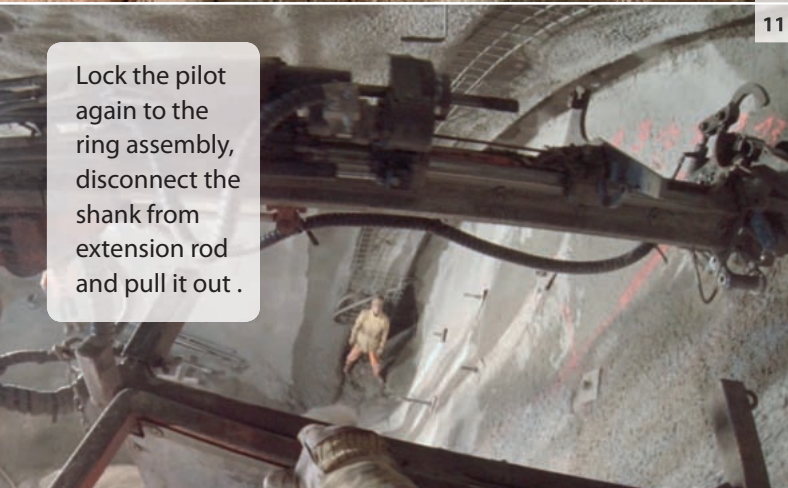

Lock the pilot again to the ring assembly, disconnect the shank from extension rod and pull it out .



Install a new set of extension casing and extension rod

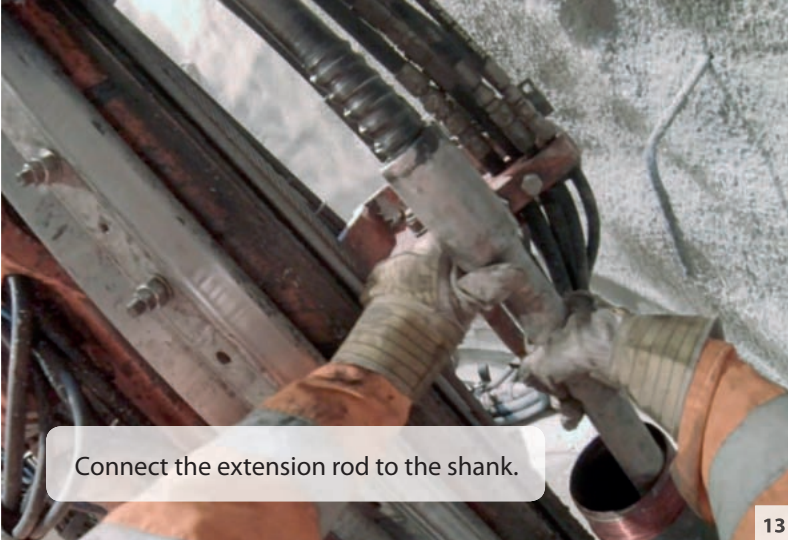

Connect the extension rod to the shank.

13 14
15 16



When the last pile of the arc has been installed...

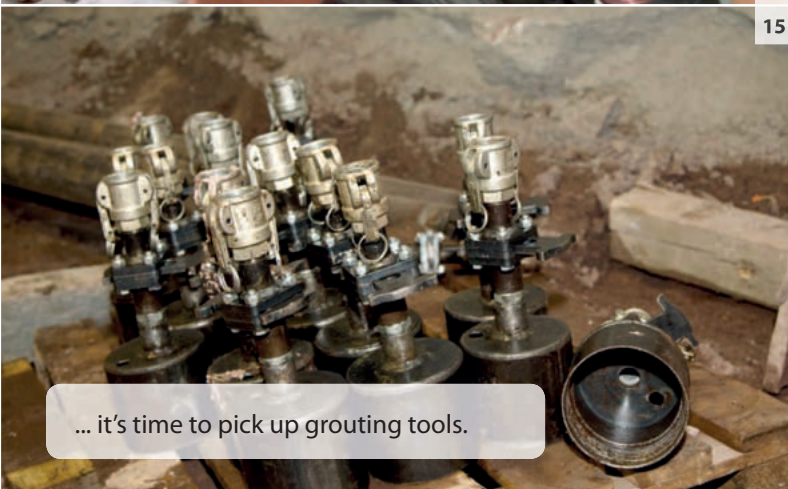

... it's time to pick up grouting tools.



Install the grouting plug (end cap) to the casing and inject the soil using cement or polyurethane grout.



If the tunnel face has been stabilized with Robit® RoX GFRP (fiberglass tubes) system with injected grout, it's easy to demolish for example with an excavator. Reinforce ceiling, install steel frames and shotcrete tunnel face.

17 18
19 20



Separate fiberglass from the excavated soil and recycle it.



Start a new section by supporting the tunnel face with Robit® RoX GFRP system.



Robit® Forepoling Products



- Pilot Bits · Ring Assemblies · Drill Rods · Starter Casings
- Extension Casings · Grouting Plugs (end caps) · Adapters
- Grouting Valves · Forepoling Drilling Systems



Robit® Patented Spiral Locking System



Automatic spiral locking (Patented):

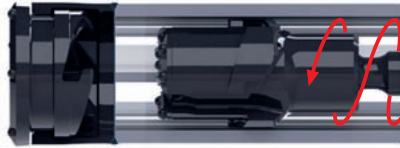

1.) Drive the pilot bit through the casing tube

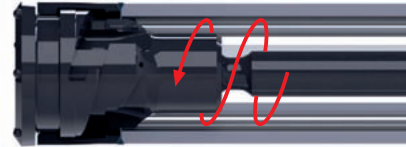

2.) Rotate to locked position in the ring bit

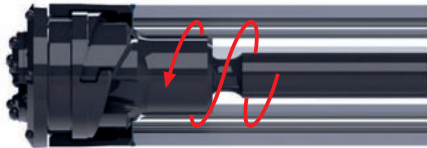

3.) Robit® Casing System is READY TO DRILL



4.) Finish drilling by rotating the pilot bit in opposite direction and pulling it out

Robit[®] Dimensions Explanation

Casing System dimensions

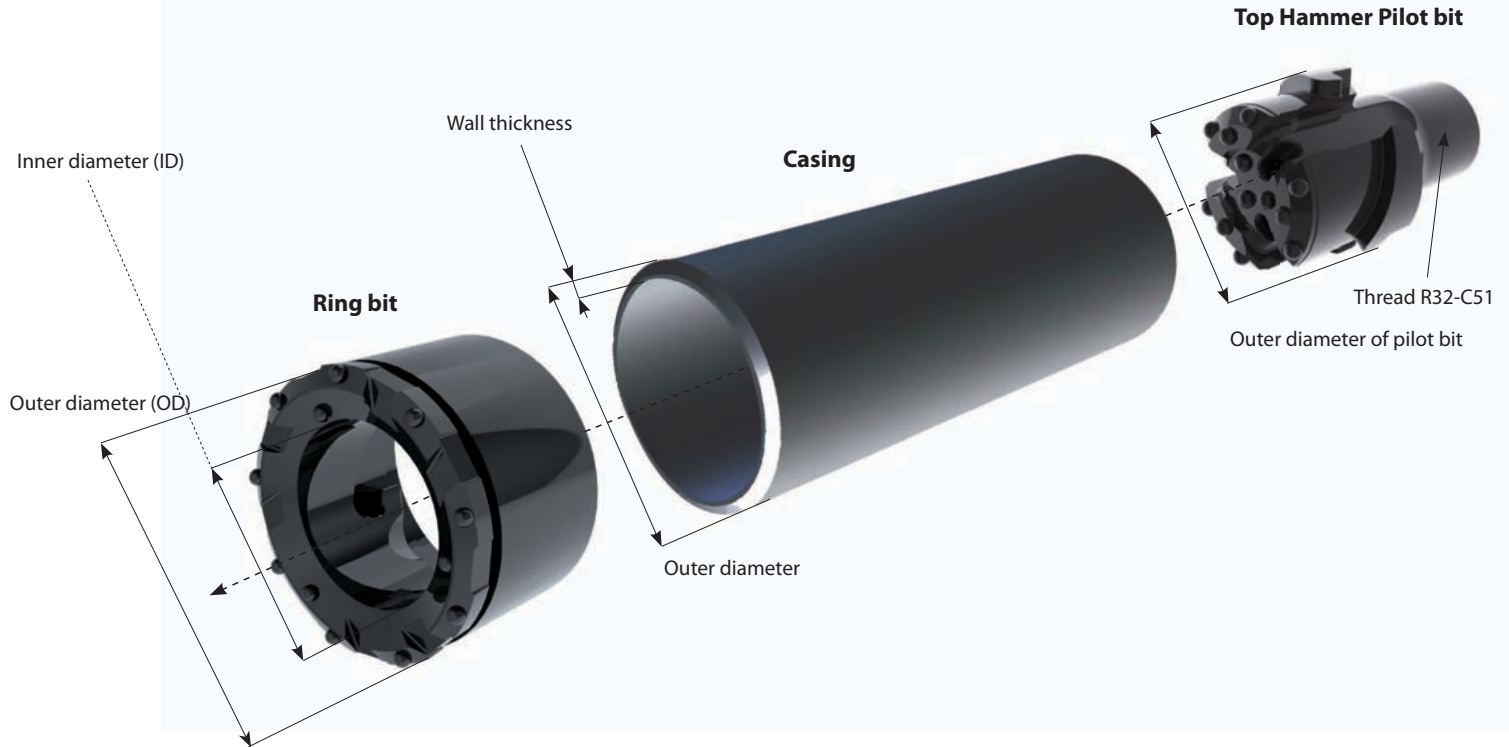

Robit® RoX in Brief: system parts

Single-use system for top hammer drilling

Robit® Single Casing Systems can be used with traditional top hammer machinery.

Typically Robit® Single-Use system for Top Hammer is used in applications with relatively short hole requirement 12-15 m and where the casing is left in the ground, such as:

- forepoling or tube umbrella
- anchoring
- micropiling

Drilling parameters example: Jumbo drill

Product	RoX+ 139,7/10
Rock / Ground conditions	All rock and ground formations
Application	Tube Umbrella, Forepoling
Top hammer thread	C45
Rotation speed	30 - 40 RPM
Torque	1000 - 1200 Nm
Percussion	75 - 100 bars

NOTE

Parameters may vary depending on ground / rock conditions, application and machinery



Robit® RoX GFRP in Brief: system parts

Single-use system for top hammer fiberglass casing

Robit® has developed a system for fiberglass casings. A unique casing shoe works as a shock-absorber protecting the casing from the drilling forces. Fiberglass casing brings several benefits:

- Lighter casings – easier to handle
- Lower material cost – more economic drilling
- Easy to excavate – drill and blast in overburden conditions
- Can be used as face bolts to stabilize the tunnel face

Robit® Fiberglass system is available for top hammer applications.

Geometrical characteristics

Technical characteristics

Section	1700 mmq.	Glass content in weight	50%
External diameter	ø 76 mm	Specific weight	1.8 g/cc
Internal diameter	ø 60 mm	Tensile strength	600 MPa
Thickness	8 mm	Flexural strength	600 MPa
Weight/m	3,2 kg	Elastic modulus	20000 MPa

NOTE

Parameters may vary depending on ground / rock conditions, application and machinery

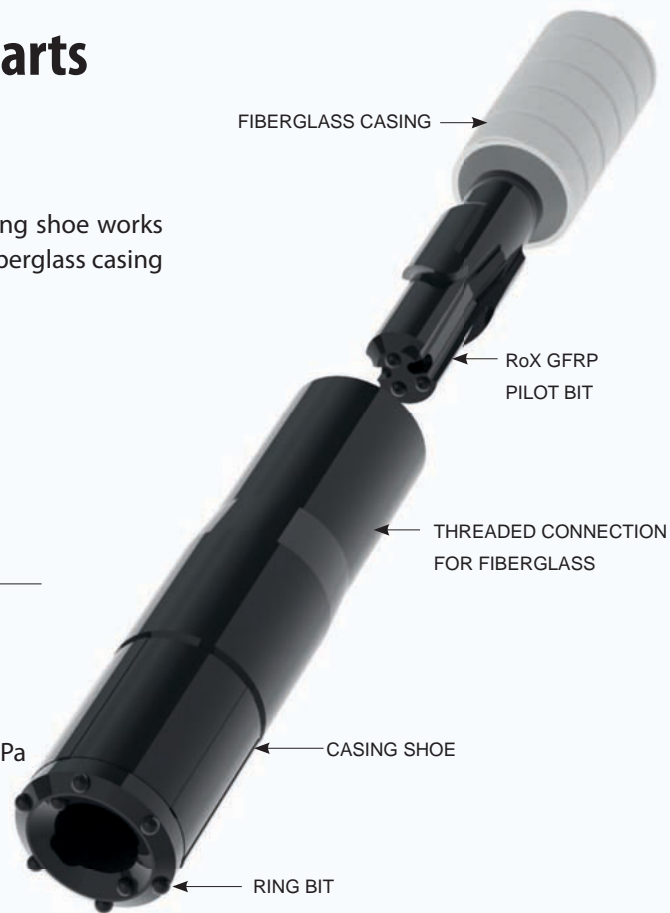

Forepoling Drilling Systems - RoX+ 88,9/8

1. **RoX+ 88,9/8 (02-238-088-0024) pilot bit C38**
2. **RoX+ 88,9/8 ring bit assembly & starter casing**
 - Steel casing $\varnothing 88,9/8$ including RoX+ 88,9/8 ring bit assembly
 - 1 side male threaded, L=3000 mm with grouting holes + valves
3. **Extension Casing**
 - Steel casing $\varnothing 88,9/8$, L=3000 mm with grouting holes + valves
 - 2 side male-female threaded, L=3000 mm
4. **Extension M/F Rod C38 - round 39 - C38, L=3050 mm (06A-07-0492) or 3660 mm (06A-07-0491)**

Optional

5. **Grouting plug (end cap)**
 - 1 side female threaded with valve
6. **Shank adapter for needed rig/drifter**



Forepoling Drilling Systems - RoX+ 101,6

1. **RoX+ 101,6/10 (02-238-101-0026) pilot bit C38**
2. **RoX+ 101,6/10 ring bit assembly & starter casing**
 - Steel casing \varnothing 101,6/10 including RoX+ 101,6/10 ring bit assembly
 - 1 side male threaded, L=3000 mm with grouting holes + valves
3. **Extension Casing**
 - Steel casing \varnothing 101,6/10, L=3000 mm with grouting holes + valves
 - 2 side male-female threaded, L=3000 mm
4. **Extension M/F Rod C38 - round 39 - C38, L=3050 mm (06A-07-0492) or 3660 mm (06A-07-0491)**

Optional

5. **Grouting plug (end cap)**
 - 1 side female threaded with valve
6. **Shank adapter for needed rig/drifter**



Forepoling Drilling Systems - RoX+ 114,3/10

1. **RoX+ 114,3/10** (02-238-114-0028) **pilot bit C38**
2. **RoX+ 114,3/10 ring bit assembly & starter casing**
 - Steel casing \varnothing 114,3/10 including RoX+ 114,3/10 ring bit assembly
 - 1 side male threaded, L=3000 mm with grouting holes + valves
3. **Extension Casing**
 - Steel casing \varnothing 114,3/10, L=3000 mm with grouting holes + valves
 - 2 side male-female threaded, L=3000 mm
4. **Extension M/F Rod C38 - round 39 - C38**, L=3050 mm (06A-07-0492) or 3660 mm (06A-07-0491)

Optional

5. **Grouting plug** (end cap)
 - 1 side female threaded with valve
6. **Shank adapter** for needed rig/drifter



Forepoling Drilling Systems - RoX 139,7

1. **RoX 139,7/10 (02-245-139-0032) pilot bit C45**
2. **RoX 139,7/10 ring bit assembly & starter casing**
 - Steel casing \varnothing 139,7/10 including RoX 139,7/10 ring bit assembly
 - 1 side male threaded, L=3000 mm with grouting holes + valves
3. **Extension Casing**
 - Steel casing \varnothing 139,7/10, L=3000 mm with grouting holes + valves
 - 2 side male-female threaded, L=3000 mm
4. **Extension M/F Rod C45 - round 46 - C45, L=3050 mm (06B-07-2882) or 3660 mm (06B-07-0501)**

Optional

5. **Grouting plug (end cap)**
 - 1 side female threaded with valve
6. **Shank adapter for needed rig/drifter**



Forepoling Drilling Systems - RoX+ 168,3

1. **RoX+ 168,3/10** (02-251-168-0038) **pilot bit C45**
2. **RoX+ 168,3/10 ring bit assembly & starter casing**
 - Steel casing $\varnothing 168,3/10$ including RoX+ 168,3/10 ring bit assembly
 - 1 side male threaded, L=3000 mm with grouting holes + valves
3. **Extension Casing**
 - Steel casing $\varnothing 168,3/10$, L=3000 mm with grouting holes + valves
 - 2 side male-female threaded, L=3000 mm
4. **Extension M/F Rod C45 - round 46 - C45**, L=3050 mm (06B-07-2882) or 3660 mm (06B-07-0501)

Optional

5. **Grouting plug** (end cap)
 - 1 side female threaded with valve
6. **Shank adapter** for needed rig/drifter



Forepoling Drilling Systems - DTH-RoX+ 139,7

1. **DTH-RoX+ 139,7/10 (03-541-139-0164) pilot bit, shank IR340**
2. **DTH-RoX+ 139,7/10 ring bit assembly & starter casing**
 - Steel casing Ø139,7/10 including DTH-RoX+ 139,7/10 ring bit assembly
 - 1 side male threaded, L=3000 mm with grouting holes + valves
3. **Extension Casing**
 - Steel casing Ø139,7/10, L=3000 mm with grouting holes + valves
 - 2 side male-female threaded, L=3000 mm
4. **Drill pipe Ø76 or Ø89, 2 $\frac{3}{8}$ A.P.I. , L=3000 mm**

Optional

5. **Grouting plug (end cap)**
 - 1 side female threaded with valve
6. **DTH hammer 4", 2 $\frac{3}{8}$ A.P.I., shank IR340**

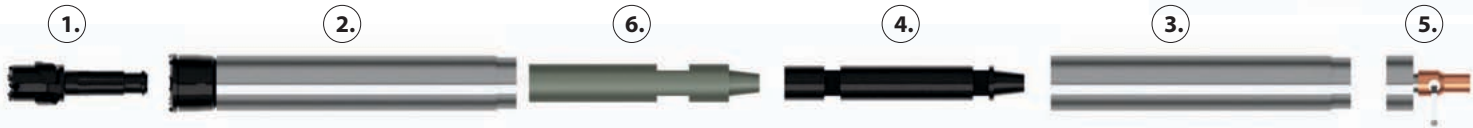

Forepoling Drilling Systems - RoX+ GFRP 76,1

1. **RoX+ GFRP 76,1/8 (02-132-076-0021) pilot bit R32**
2. **RoX+ GFRP 76,1/8 ring bit assembly & starter casing**
 - Fiberglass casing Ø76,1/8 including RoX+ GFRP 76,1/8 ring bit assembly
 - 1 side male threaded, L=2700 mm with grouting holes + valves
3. **Extension Casing**
 - Fiberglass casing Ø76,1/8 including steel coupling, L=3000 mm with grouting holes + valves
 - 2 side male-male threaded, L=3000 mm
4. **Extension M/F Rod R32 - round 32 - R32, L=3050 mm (06B-07-2877) or 3660 mm (06B-07-2492)**

Optional

5. **Grouting plug (end cap)**
 - 1 side female threaded with valve
6. **Shank adapter for needed rig**

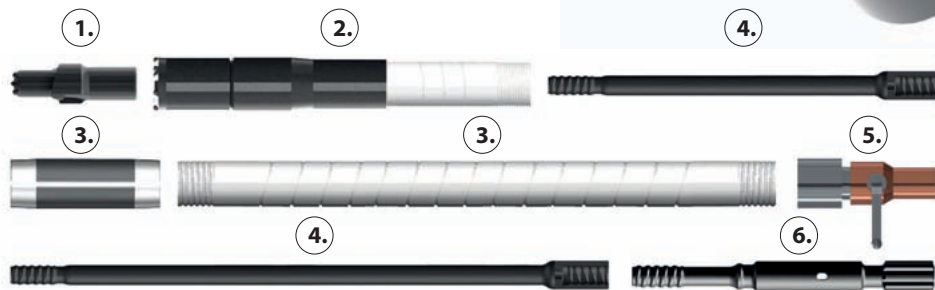



Product codes & part numbers: RoX+

Order code

Casing

Ring bit

Pilot bit

Thread

Product number



[mm]

[in]



[mm]

[in]



[mm]

[in]



[mm]

[in]



[mm]

[in]



RoX+ 76,1/4	76,1	3	4	0.157	52	2.047	90	3.543	66	2.598	R32	02-132-076-5433	02-011-076-5430
RoX+ 76,1/8	76,1	3	8	0.315	47	1.850	90	3.543	59	2.323	R32	02-132-076-0021	02-011-076-0001
RoX+ 88,9/4	88,9	3 ½	4	0.157	71	2.795	99	3.898	80	3.150	C38	02-238-088-0022	02-011-088-0003
RoX+ 88,9/8	88,9	3 ½	8	0.315	50,8	2.000	94,9	3.736	70	2.756	C38	02-238-088-6412	02-011-088-0006
RoX+ 101,6/10	101,6	4	10	0.394	65	2.559	110	4.331	79	3.110	C38	02-238-101-0026	02-011-101-0012
RoX+ 114,3/5	114,3	4 ½	5	0.197	91	3.583	128	5.039	102	4.016	C38	02-238-114-3344	02-011-114-3346
RoX 114,3/10	114,3	4 ½	10	0.394	73,5	2.894	120,3	4.736	92,5	3.642	C38	02-238-114-0028	02-011-114-0014
RoX 139,7/10	139,7	5 ½	10	0.394	94	3.701	145,7	5.736	117,5	4.626	C45	02-245-139-0032	02-011-139-0016
RoX+ 159,0/10	159,0	6 ¼	10	0.394	119	4.685	169	6.654	137	5.394	C45	02-245-159-3100	02-011-159-3103
RoX+ 168,3/10	168,3	6 ⅝	10	0.394	127	5.000	182,3	7.177	147	5.787	C45	02-251-168-0038	02-011-168-0019
RoX+ 219,1/12,7	219,1	8 ⅝	12,7	0.500	167	6.575	234	9.213	191	7.520	C45	02-245-219-5708	02-011-219-5706

Robit C -thread corresponds T, FI, etc.



Top Hammer pilot bit



Top Hammer ring bit

Product codes & part numbers: RoX+ GFRP

Order code

Casing

Ring bit

Pilot bit

Thread

Product number

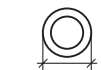

[mm]

[in]



[mm]

[in]



[mm]

[in]



[mm]

[in]



[mm]

[in]



RoX+ GFRP 76,1/8	76,1	3	8	0.315	47	1.850	90	3.543	59	2.323	R32	02-132-076-0021	02-011-076-2382
RoX+ GFRP 76,1/8	76,1	3	8	0.315	47	1.850	90	3.543	59	2.323	C35	02-235-076-5449	02-011-076-2382

Robit C -thread corresponds T, FI, etc.



Top Hammer GFRP pilot bit



Top Hammer GFRP ring bit

Extension Rod (Male/Female) - R32 (1 ¼”), C38 (1 ½”) and C45 (1 ¾”) bit threads

Order code	Length		Diameter	Thread		Flushing	Product number	Weight	Pcs/box
	L			D					
	[mm]	[ft - in]	[mm]	[A]	[B]	[mm]		[kg]	
Extension M/F Rod R32 - round 32 - R32									
MF-R32-32R-R32-3050	3050	10'	RND32	R32	R32	11,7	06B-07-2877	17,1	32
MF-R32-32R-R32-3660	3660	12'	RND32	R32	R32	11,7	06B-07-2492	20,9	32
Extension M/F Rod C38 - round 39 - C38									
MF-C38-39R-C38-3050	3050	10'	RND39	C38	C38	14,5	06B-07-2199	25,6	24
MF-C38-39R-C38-3660	3660	12'	RND39	C38	C38	14,5	06B-07-2491	30,4	24
Extension M/F Rod C45 - round 46 - C45									
MF-C45-46R-C45-3050	3050	10'	RND46	C45	C45	17,0	06B-07-2882	35,7	24
MF-C45-46R-C45-3660	3660	12'	RND46	C45	C45	17,0	06B-07-0501	42,5	24

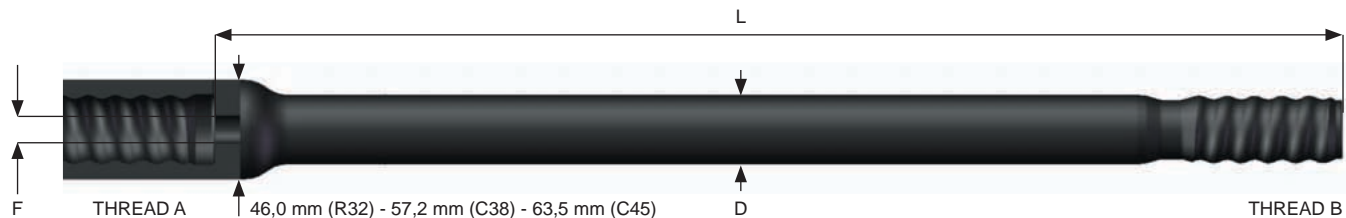

Drill Tubes - Starter Casing

e.g. for RoX+ 114,3

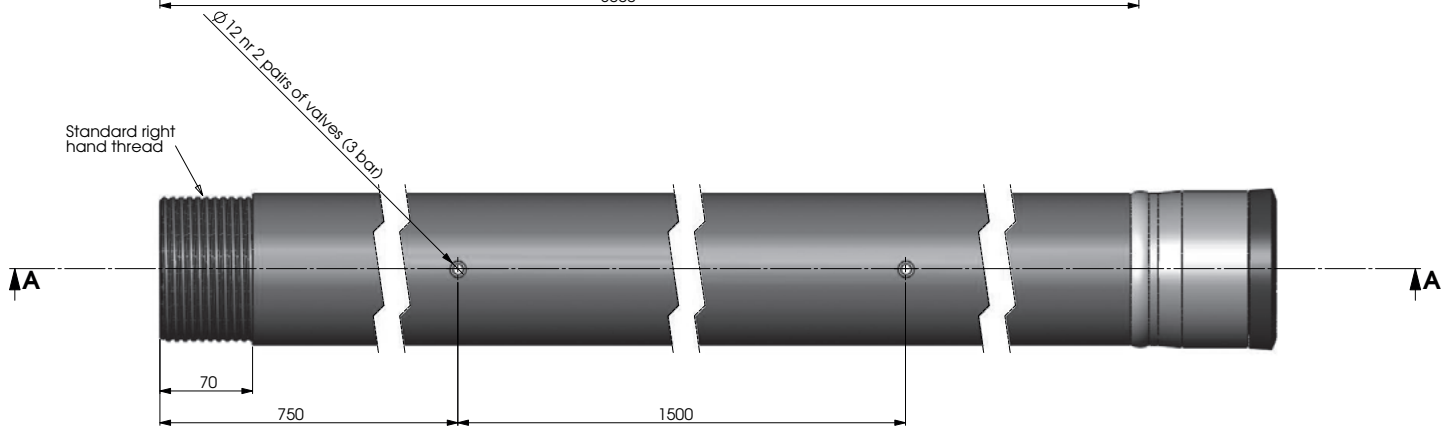
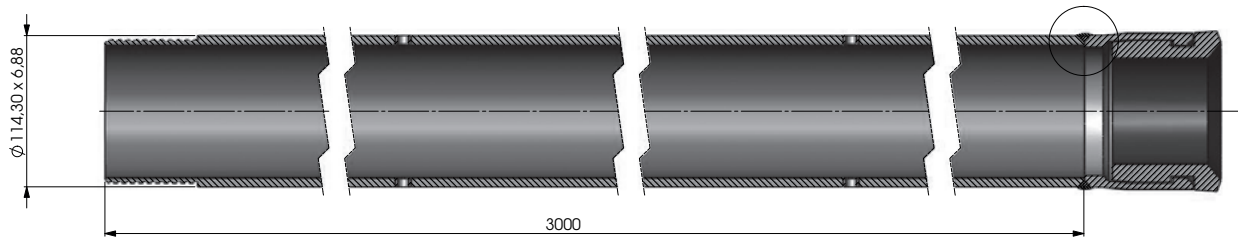
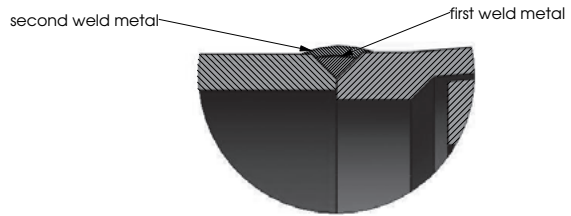

Drill Tubes - Extension Casing, Male-Female

e.g. for RoX+ 114,3

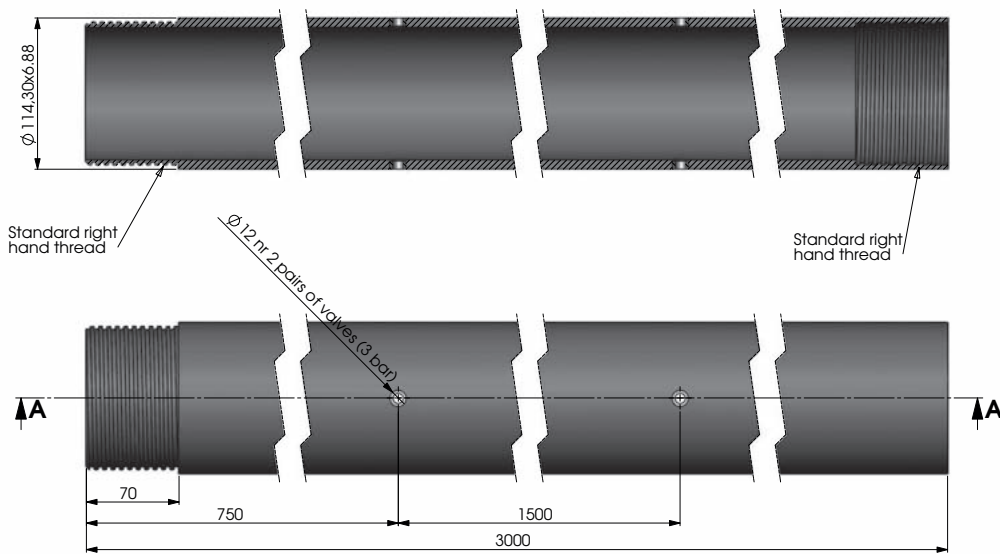

Notes

Robit

ROBIT PLC

Vikkiniityntie 9

FI-33880 LEMPÄÄLÄ (TAMPERE)

FINLAND

Tel: +358 3 3140 3400

E-mail: sales@robitgroup.com

<http://www.robitgroup.com>

Your distributor:



Robit reserves all rights to any changes in the products and the specifications without prior notice.

Printed: January 2019

Copyright © 2019 by Robit Plc

1/2019

ROBIT® FOREPOLING PRODUCT CATALOGUE