

# KOMATSU

## PW158-11



Hydraulic wheeled excavator

**Engine power**  
110 kW / 148 HP @ 2000 rpm

**Operating weight**  
15125 - 17360 kg

**Bucket capacity**  
max. 0.94 m<sup>3</sup>

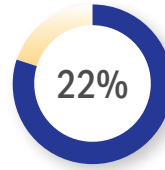

**More powerful**

Higher engine power:  
+20 kW vs previous model



**Save time**

Higher uphill travel speed:  
+30% vs previous model



**Save costs**

Reduced fuel consumption:  
-5% vs previous model



Engine power  
**110 kW / 148 HP @ 2000 rpm**

Operating weight  
**15125 - 17360 kg**

Bucket capacity  
**max. 0.94 m<sup>3</sup>**

# High versatility, low fuel consumption and safe performance in tight spaces

## Powerful and environmentally friendly

- EU Stage V engine
- Adjustable idle shutdown
- Komatsu fuel-saving technology
- Excellent travel performance
- High lifting capacity

## Total versatility

- Compact design with short tail swing radius
- Ideal for a wide range of applications
- Additional hydraulic circuit
- Komatsu Integrated Attachment Control (KIAC) (option)
- A wide choice of options

## First-class operator comfort

- Air-suspended operator seat with integrated joystick consoles
- Premium air-suspended operator seat (option)
- Boom suspension system (ECSS) (option)
- KomVision surround view system
- Widescreen monitor
- Joystick steering system (option)

## State-of-the-art controls

- Proportional controls for attachments
- Improved, ergonomic switches
- 6 working modes

## Easy maintenance

- Ground level service access
- Centralised greasing system
- User-friendly location of the electric refuelling pump
- Simple access to the AdBlue® tank

## Komtrax

- Komatsu Wireless Monitoring System
- 4G mobile communications
- Increased operational data and fuel savings
- Integrated communication antenna



A maintenance program  
for Komatsu customers



### Higher productivity

Along with its compact size, the PW158-11 features an unrivalled lifting performance. The combination of power, weight distribution, convenient dimensions and complete control makes it the top choice for heavy-duty lifting applications, simple excavating tasks in narrow alleys, and for road and sewer construction sites.

### Komatsu fuel-saving technology

Fuel consumption on the PW158-11 is lower by up to 5% vs previous model. Engine management is enhanced. The variable speed matching of the engine and hydraulic pumps guarantee efficiency and precision during single and combined movements. A viscous clutch enables variable cooling fan speed to further reduce fuel consumption.

### Adjustable idle shutdown

The Komatsu auto idle shutdown automatically turns off the engine after it idles for a set period of time. This feature can easily be programmed from 5 to 60 minutes, to reduce unnecessary fuel consumption and exhaust emissions, and to lower operating costs. An Eco-gauge and the Eco guidance tips on the cab monitor further encourage efficient operations.

# Powerful and environmentally friendly

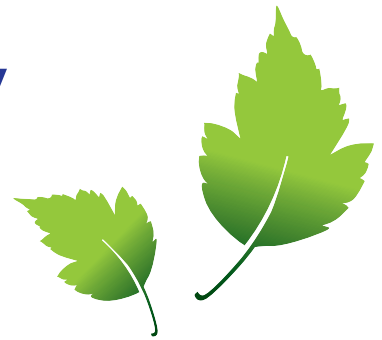

## Komatsu EU Stage V

The Komatsu EU Stage V engine is productive, dependable and efficient. With ultra-low emissions, it provides a lower environmental impact and a superior performance to help reduce operating costs and lets the operator work in complete peace of mind.

## Heavy-duty aftertreatment

The aftertreatment system combines a Komatsu Diesel Particulate Filter (KDPF) and Selective Catalytic Reduction (SCR). The SCR injects the correct amount of AdBlue® into the system at the proper rate to break down NOx into water (H<sub>2</sub>O) and non-toxic nitrogen gas (N<sub>2</sub>).

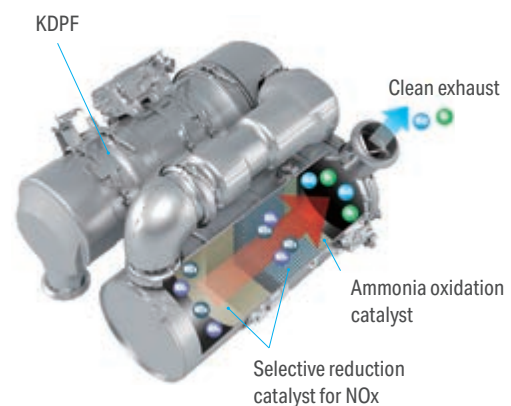

## High-Pressure Common Rail (HPCR)

To achieve complete fuel burn and lower exhaust emissions, the heavy-duty High-Pressure Common Rail fuel injection system is computer controlled to deliver a precise quantity of pressurised fuel into the redesigned engine combustion chamber by multiple injections.

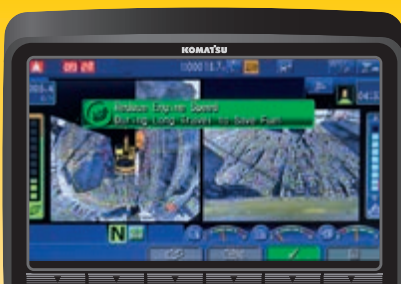
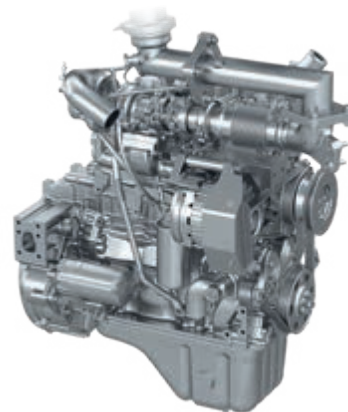

Eco-gauge, Eco guidance and fuel consumption gauge

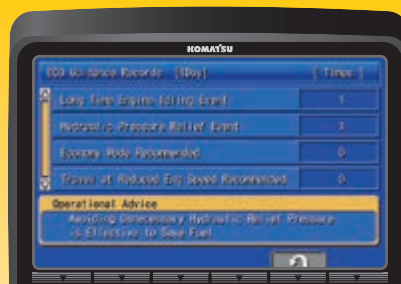

Eco guidance record



Fuel consumption history

## Compact design

The PW158-11 is perfect for confined work sites, with a compact design and a tail swing radius of only 1.9 m. In urbanised areas, but also on road or sewer construction sites where space is limited, the PW158-11 is a high output performer and offers more safety and less worries for the operator.

## Additional hydraulic circuit

To allow the use of many attachments, such as buckets, breakers or clamshell buckets, an additional hydraulic circuit controlled by a sliding joystick button is standard on the PW158-11. To further increase versatility and flexibility, a second optional auxiliary circuit and an optional hydraulic quick-coupler actuation are also available. In combination with the Komatsu Integrated Attachment Control (KIAC), changing and operating different attachments becomes child's play.



Total versatility



## Total versatility



### Quick-couplers

Lehnhoff quick-couplers – mechanical, hydraulic or fully hydraulic – are available for factory installation. They can turn an excavator into a multi-functional tool carrier for any type of attachment. All quick-couplers offer high functional safety thanks to their sealed locking mechanisms and hydraulics. The Lehmatic Safety Control (LSC) assistant system is integrated into the machine's monitor and gives the operator full control of the Lehnhoff quick coupler's locking status.



### Automatic digging brake

This new optional digging brake automatically activates the service brake and oscillation lock when the machine stops, and it releases them when the machine accelerates again. The operator can fully focus on the job with no need to step on the brake.



### Trailer hitch

For increased versatility, the PW158-11 can be equipped with either a car ball type hitch, an agricultural ball type hitch, or a truck type automatic hitch, for trailers up to 7.5 tonnes with an overrun brake. All necessary electric and hydraulic hook-ups are provided, including two auxiliary undercarriage circuits for dumping or tail-gate operation. These trailer functions can be operated from the cab joysticks.

### Boom suspension system (ECSS)

An optional electrical controlled suspension system (ECSS) for the boom provides a significant increase in comfort when traveling over bumps.

### Standard or wide axles

No matter the job, with a small turning radius and excellent traction the axles are built for a maximum performance. For even better stability a 2750 mm wide axle is available. If more traction is needed, an optional 35% differential lock helps to get over rough terrain. To keep the machine cleaner, robust fenders are also available as option.







Komatsu Integrated Attachment Control (KIAC)



Adjustable oil flow

### Komatsu Integrated Attachment Control (KIAC) (option)

For fast and safe tool changes without leaving the cab, the settings for oil flow and pressure of up to 15 hydraulic attachments are available as presets directly on the monitor panel. Komatsu Integrated Attachment Control (KIAC) includes adjustments for the first and second (optional) hydraulic circuits. Selecting the breaker mode automatically cuts all pressure in the return line.



## Increased comfort

The SpaceCab™ provides an ergonomic and quiet work environment, with an outstanding view of the jobsite. ROPS certified, it was specifically designed by Komatsu for hydraulic excavators, with a reinforced pipe-structured framework set up on viscous damper mounts for low vibration levels. The standard telescopic steering wheel is comfortably adjustable in height and reach.

## Improved operator convenience

With increased in-cab storage space, an auxiliary input (MP3 jack) and 12 V and 24 V power supply, the cab offers maximum convenience. The automatic air conditioner allows the operator to easily and precisely set the cab's atmosphere.

## Premium comfort seat (option)

The premium comfort seat comes with suspended joystick consoles, top quality cushioning, auto weight adjustment, pneumatic lumbar support and a climate control system for perfect seat temperature adjustment.

## Low-noise design

Komatsu wheeled excavators have very low external noise levels and are especially well-suited for work in confined spaces or urban areas. The optimal usage of sound insulation and of sound absorbing materials helps to make noise levels inside the cab comparable to those of an executive car.



Premium comfort seat (option)



Exceptionally good overview of the surroundings from the cab

## First-class comfort

### Easy operation

The Komatsu PW158-11 features an operational concept that puts full control of the machine right at the operator's fingertips. Different camera views, undercarriage attachments and the manual axle lock can all be actuated by buttons on top of the operational levers. Without removing the hand from the joystick, the operator can switch from boom operation to undercarriage control for complete and precise control over the parallel dozer blade.



Ergonomically designed switches that light up for safe and easy night operation



Ergonomic joysticks with proportional controls

### Proportional controls

The ergonomic joysticks with proportional controls were specially redesigned and developed for working with a wheeled excavator. They have horizontal sliders for the first and second (optional) hydraulic circuits and offer safe and precise operation of attachments such as ditch cleaning buckets, sorting grapples, clamshell buckets, tilt rotators and of many other hydraulic attachments that require very fine control.

### 6 working modes

The PW158-11 delivers the required power with the lowest fuel consumption. 6 working modes are available: Power, Lifting/Fine Operation, Breaker, Economy, Attachment Power and Attachment Economy. The operator can ideally balance the Economy mode between power and economy to match the work at hand.



### Joystick steering

With the optional joystick steering the operator can precisely fingertip control the machine on any jobsite. This allows the easy combined operation of driving and working with the attachment simultaneously.



**An evolutionary interface**

Helpful information is now easier than ever to find and understand with the upgraded monitor interface. An optimal main screen for the ongoing work can be selected simply by pressing the F6 key.

**Lower operating costs**

Komatsu ICT contributes to the reduction of operating costs by assisting to comfortably and efficiently manage operations. It raises the level of customer satisfaction and the competitive edge of our products.

**Widescreen monitor**

Installed with a choice of 26 languages, the widescreen monitor with simple switches and multifunction keys gives fingertip access to a large range of functions and operating info.

Equipped with universal piping for attachments such as breakers, the conversion to a low-pressure mode requires only a push of the breaker mode switch on the monitor.



Quick view on the operation logs



With KomVision, various camera view options help to maintain a constant bird's eye view from above the machine



Operator identification function

## Information & communication technology



### Knowledge

You get quick answers to basic and critical questions about your machines – what they're doing, when they did it, where they're located, how they can be used more efficiently and when they need to be serviced. Performance data is relayed by wireless communication technology (satellite, GPRS or 4G depending on model) from the machine to a computer and to the local Komatsu distributor – who's readily available for expert analysis and feedback.

### Convenience

Komtrax enables convenient fleet management on the web, wherever you are. Data is analysed and packaged specifically for effortless and intuitive viewing in maps, lists, graphs and charts. You can foresee eventual maintenance issues and required spare parts, and troubleshoot a problem before Komatsu technicians arrive on site.



### The way to higher productivity

Komtrax uses the latest wireless monitoring technology. Compatible on PC, smartphone or tablet, it delivers insightful and cost saving information about your fleet and equipment, and offers a wealth of information to facilitate peak machine performance. By creating a tightly integrated web of support it allows proactive and preventive maintenance and helps to efficiently run a business.

### Power

The detailed information that Komtrax puts at your fingertips 24 hours a day, 7 days a week gives the power to make better daily and long-term strategic decisions – at no extra cost. Problems can be anticipated, maintenance schedules customised, downtime minimised and machines kept where they belong: working on the jobsite.



## Optimal jobsite safety

Safety features on the Komatsu PW158-11 comply with the latest industry standards and work in synergy to minimise risks to people in and around the machine. A neutral detection system for travel and work equipment levers increase jobsite safety, along with a seat belt caution indicator and an audible travel alarm. Highly durable anti-slip plates – with additional high friction covering – maintain long term traction performance.



## Safe operation in confined areas

The compact tail design minimises the risks of rear impact and lets the operator concentrate fully on the job. The machine can work safely in narrow spaces or in obstructed areas.



KomVision cameras



Handrails and anti-slip plates

## KomVision

With a series of high definition networked cameras fitted on the machine, KomVision provides a crystal clear, real-time bird's eye view of the immediate surroundings on the widescreen cab monitor. The operator can quickly and easily check the machine's vicinity prior to making any movement, and focus on the work at hand even in low light conditions.

## Safe maintenance

Thermal guards around high temperature areas of the engine, protected fan belt and pulleys, a pump/engine partition that prevents hydraulic oil from spraying onto the engine, and exceptionally sturdy handrails: in Komatsu tradition, the highest safety level is provided for a fast and smooth maintenance.



## Easy maintenance

### Simple and convenient service

The large doors and engine hood give convenient access to all daily service points. Filters are centralised and required service intervals are longer to keep machine downtime to a minimum.

### Remote greasing bar

The PW158-11 features a centralised system that facilitates the regular greasing of the boom. An optional fully automatic greasing system can handle the regular and proper greasing of the complete machine – prolonging the lifetime and increasing the resale value of the excavator.

### Electric refuelling pump

Standard equipment on all PW158-11 includes an automatic shut-off fuelling pump that allows easy refuelling from a barrel.

### Easy radiator access

Thanks to a side-by-side cooler arrangement, the aftercooler and hydraulic oil radiator can be cleaned easily and repaired individually in case of damage.

### Komatsu Care

Komatsu Care is a maintenance program that comes as standard with your new Komatsu machine. It covers factory-scheduled maintenance, performed with Komatsu Genuine parts by Komatsu-trained technicians. It also offers extended coverage of the Komatsu Diesel Particulate Filter (KDPF) and of the Selective Catalytic Reduction (SCR). Please contact your local Komatsu distributor for terms and conditions.

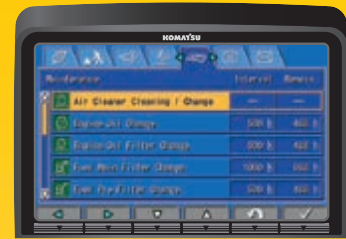

Basic maintenance screen



AdBlue® level and refill guidance



Simple access to the AdBlue® tank



Automatic greasing system (option)



# Specifications

# PW158-11E0

## Engine

Model	Komatsu SAA4D107E-5
Type	Common rail direct injection, water-cooled, emissionised, turbocharged, after-cooled diesel
Engine power	
at rated engine speed	2000 rpm
ISO 14396	110 kW / 148 HP
ISO 9249 (net engine power)	110 kW / 148 HP
No. of cylinders	4
Bore × stroke	107 × 124 mm
Displacement	4.5 l
Air filter type	Double element type with monitor panel dust indicator and auto dust evacuator
Cooling	Suction type cooling fan with radiator fly screen
Fuel	Diesel fuel, conforming to EN590 Class 2/ Grade D. Paraffinic fuel capability (HVO, GTL, BTL), conforming to EN 15940:2016

## Hydraulic system

Type	HydrauMind. Closed-centre system with load sensing and pressure compensation valves
Additional circuits	Depending on the specification up to 2 additional proportional control & quick-coupler circuits can be installed
Main pump	Variable displacement piston pump supplying boom, arm, bucket, swing and travel circuits
Maximum pump flow	244 l/min
Relief valve settings	
Implement	380 kg/cm <sup>2</sup>
Travel	420 kg/cm <sup>2</sup>
Swing	280 kg/cm <sup>2</sup>
Pilot circuit	36 kg/cm <sup>2</sup>

## Swing system

Type	Axial piston motor driving through planetary double reduction gearbox
Swing lock	Electrically actuated wet multi-disc brake integrated into swing motor
Swing speed	0 - 11 rpm
Swing torque	31 kNm

## Steering system

Steering control	Hydraulic steering system supplied from a separate gear pump and controlled through LS orbitrol & priority valves
Minimum turning radius	6450 mm (to center of outer wheel)

## Brake system

Type	Dual circuit hydraulic braking system supplied from a separate gear pump
Service brakes	Pedal actuated wet multi-disc brakes integrated into the axle hubs
Parking brake	Electrically actuated wet multi-disc "spring actuation hydraulic release" brake integrated into the transmission

## Transmission

Type	Fully automatic power shift transmission with permanent 4 wheel drive
Travel motors	One variable displacement axial piston motor
Maximum pressure	380 bar
Travel modes	Automatic + 3 travel modes
Max. travel speeds	
Hi / Lo / Creep	35.0 / 10.0 / 2.5 km/h
	A max. speed restriction of 20 km/h is available as an option
Maximum drawbar pull	8300 kg
Axle oscillation	10° Lockable in any position from the operator cab

## Service refill capacities

Fuel tank	250 l
Radiator	22 l
Engine oil	18 l
Swing drive	2.5 l
Hydraulic tank	169 l
Transmission	3.0 l
Front differential	9.5 l
Rear differential	12.4 l
Front axle hub	2.5 l
Rear axle hub	2.5 l
Swing pinion grease bath amount	10.5 l
AdBlue® tank	57.7 l

## Environment

Engine emissions	Fully complies with EU Stage V exhaust emission regulations
Noise levels	
LwA external	101 dB(A) (2000/14/EC Stage II)
LpA operator ear	69 dB(A) (ISO 6396 dynamic test)
Vibration levels (EN 12096:1997)	
Hand/arm	≤ 2.5 m/s <sup>2</sup> (uncertainty K = 0.34 m/s <sup>2</sup> )
Body	≤ 0.5 m/s <sup>2</sup> (uncertainty K = 0.16 m/s <sup>2</sup> )
Contains fluorinated greenhouse gas HFC-134a (GWP 1430).	
Quantity of gas 0.9 kg; CO <sub>2</sub> equivalent 1.29 t	



### Operating weight (appr.)

Undercarriage attachment type	Mono boom	Two-piece boom
Without	15125 kg	15365 kg
Rear blade	15855 kg	16090 kg
Rear outrigger	16125 kg	16360 kg
2 outriggers + blade	16855 kg	17090 kg
4 outriggers	17125 kg	17360 kg

Operating weight, including specified work equipment, 2500 mm arm, operator, lubricant, coolant, full fuel tank, bucket (475 kg) and the standard equipment.

### Max. bucket capacity and weight

Arm length	Mono boom					
	2100 mm		2500 mm		3000 mm	
Material weight up to 1.2 t/m <sup>3</sup>	0.94 m <sup>3</sup>	680 kg	0.94 m <sup>3</sup>	680 kg	0.75 m <sup>3</sup>	600 kg
Material weight up to 1.5 t/m <sup>3</sup>	0.85 m <sup>3</sup>	640 kg	0.75 m <sup>3</sup>	600 kg	0.66 m <sup>3</sup>	535 kg
Material weight up to 1.8 t/m <sup>3</sup>	0.75 m <sup>3</sup>	600 kg	0.66 m <sup>3</sup>	535 kg	0.56 m <sup>3</sup>	520 kg

Arm length	Two-piece boom					
	2100 mm		2500 mm		3000 mm	
Material weight up to 1.2 t/m <sup>3</sup>	0.85 m <sup>3</sup>	640 kg	0.75 m <sup>3</sup>	600 kg	0.66 m <sup>3</sup>	535 kg
Material weight up to 1.5 t/m <sup>3</sup>	0.75 m <sup>3</sup>	600 kg	0.66 m <sup>3</sup>	535 kg	0.56 m <sup>3</sup>	520 kg
Material weight up to 1.8 t/m <sup>3</sup>	0.66 m <sup>3</sup>	535 kg	0.56 m <sup>3</sup>	520 kg	0.47 m <sup>3</sup>	457 kg

Max. capacity and weight have been calculated according to ISO 10567:2007.

Please consult with your distributor for the correct selection of buckets and attachments to suit the application.

### Bucket and arm force

Arm length	2100 mm	2500 mm	3000 mm
Bucket digging force	86 kN	86 kN	86 kN
Bucket digging force at PowerMax	93 kN	93 kN	93 kN
Arm crowd force	74 kN	62 kN	52 kN
Arm crowd force at PowerMax	80 kN	67 kN	56 kN

# Dimensions and performance figures

## Mono boom

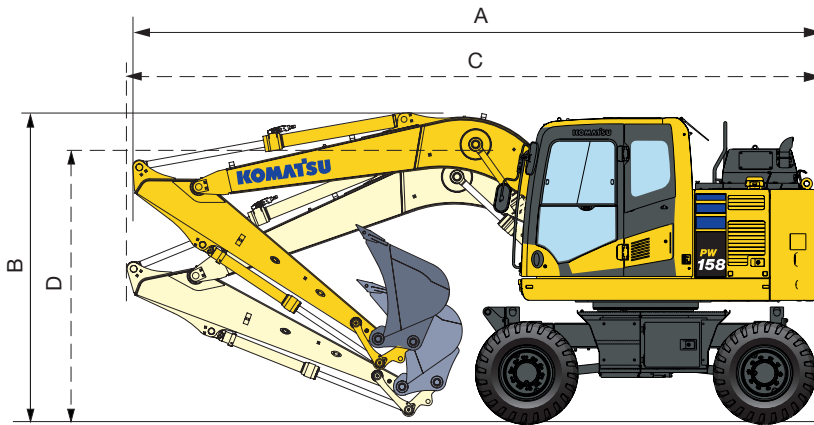

### Driving position

Arm length	A	B
2100 mm	7170 mm	3645 mm
2500 mm	7170 mm	3645 mm
3000 mm *	7215 mm	3665 mm

### Transport position

Arm length	C	D
2100 mm	7450 mm	2845 mm
2500 mm	7425 mm	2945 mm
3000 mm	7430 mm	3220 mm

\* Driving position without bucket

## Two-piece boom

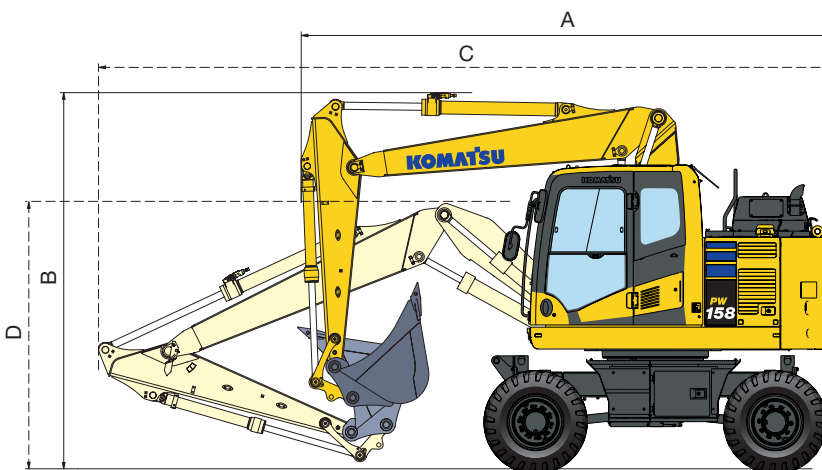

### Driving position

Arm length	A	B
2100 mm	5685 mm	3970 mm
2500 mm	5685 mm	3970 mm
3000 mm *	6205 mm	3970 mm

### Transport position

Arm length	C	D**
2100 mm	7740 mm	3155 mm
2500 mm	7740 mm	3155 mm
3000 mm	7740 mm	3155 mm

\* Driving position without bucket

\*\* Height to top of hose

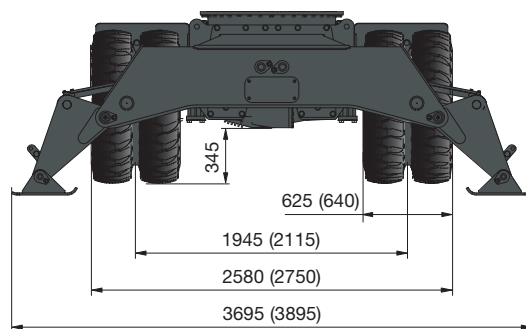
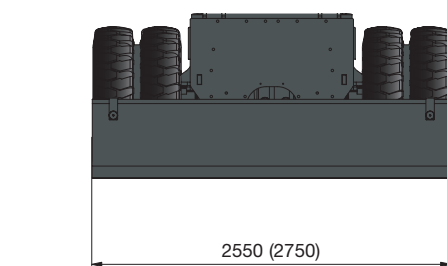
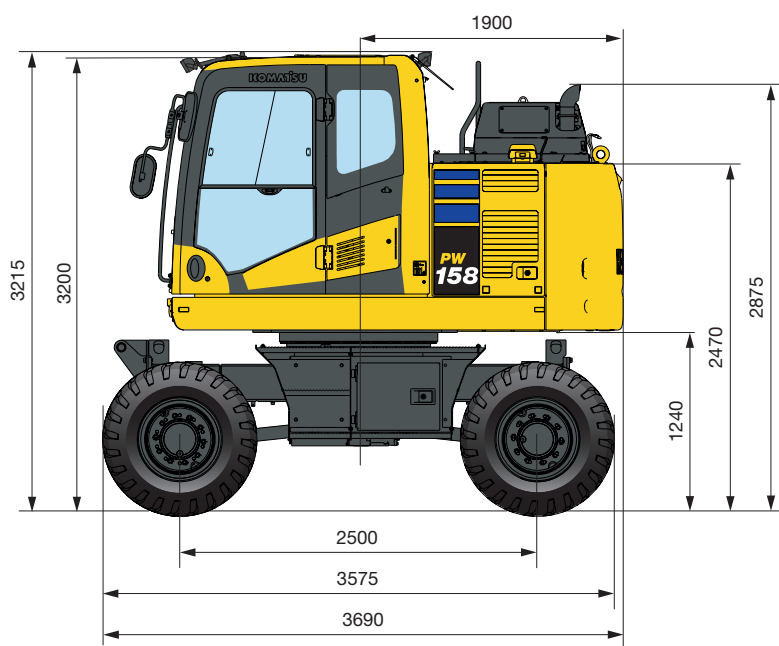

All dimensions with tyres Bandenmarkt Excavator 315/70 R225

( ): Figures for 2.75 m undercarriage

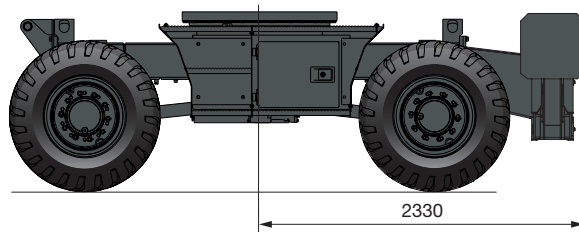
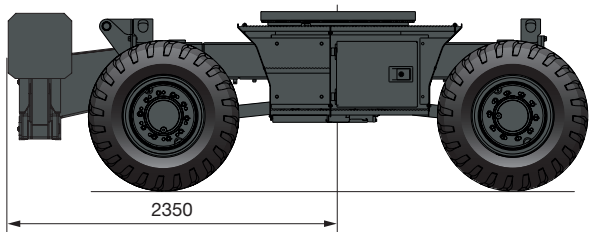
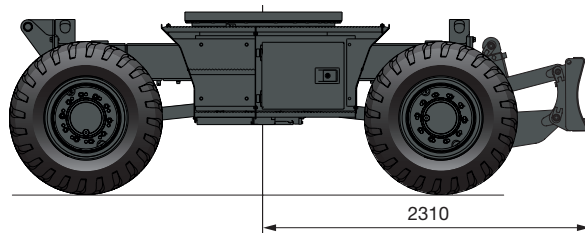
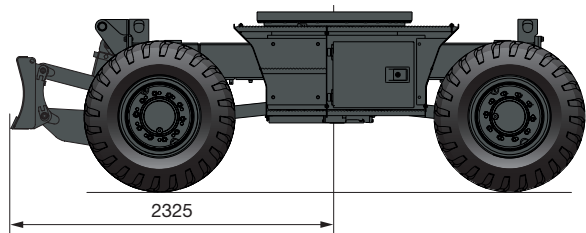

# Working range

## Mono boom

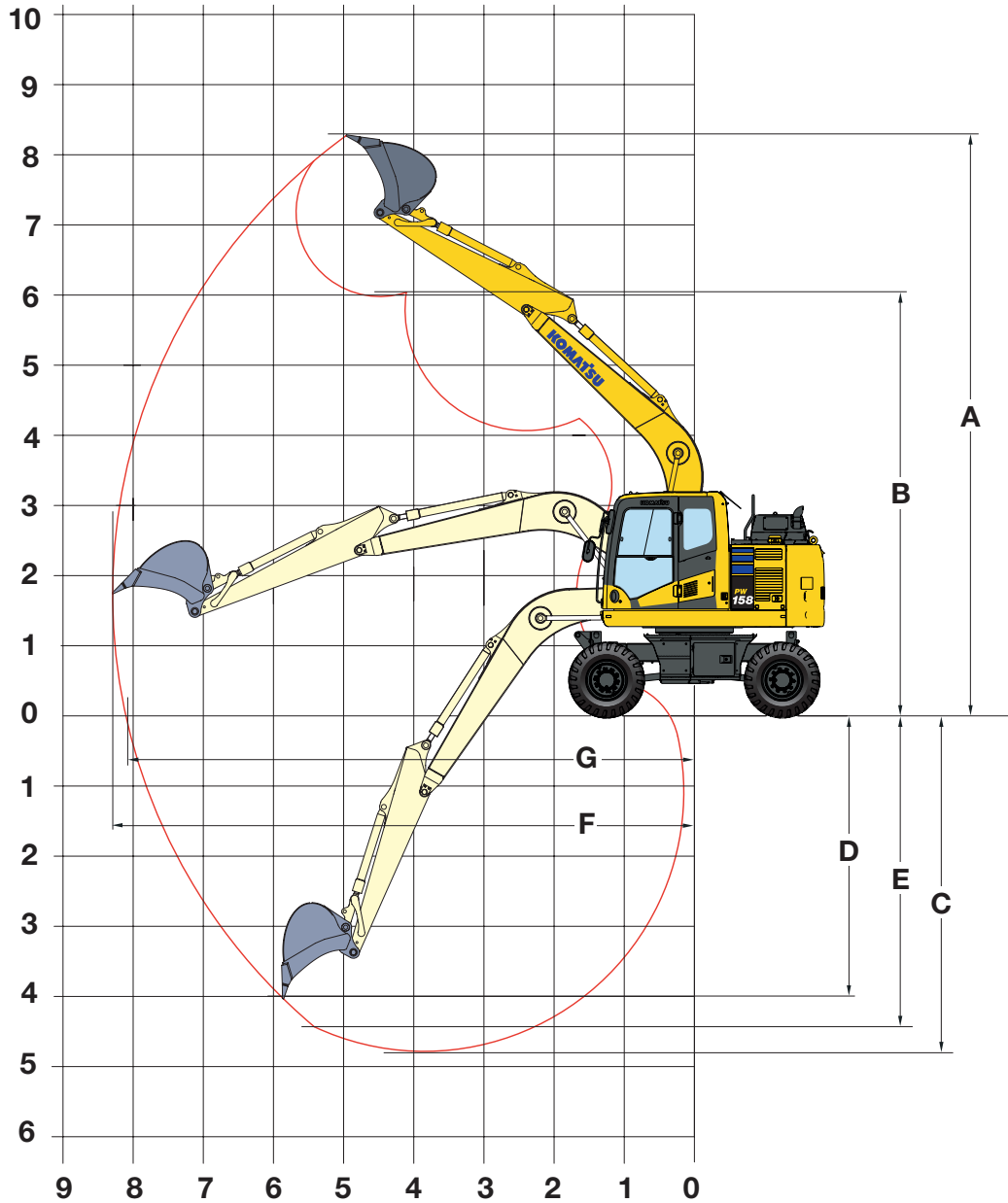

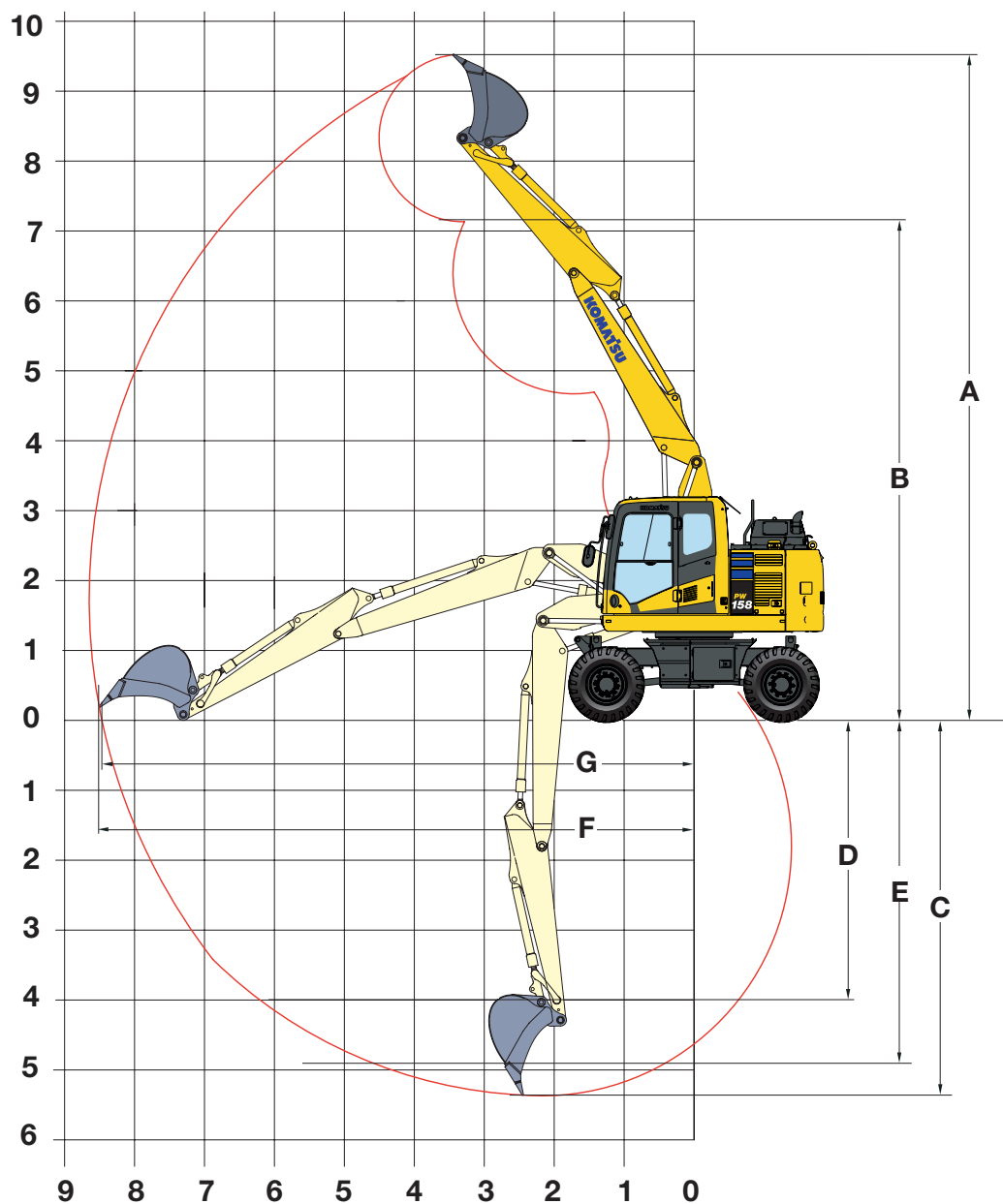

Arm length	2100 mm	2500 mm	3000 mm
A Max digging height	7980 mm	8270 mm	8703 mm
B Max dumping height	5731 mm	6020 mm	6447 mm
C Max digging depth	4462 mm	4860 mm	5362 mm
D Max vertical wall digging depth	3630 mm	4005 mm	4470 mm
E Max digging depth of cut for 2440 mm level	4025 mm	4570 mm	4955 mm
F Max digging reach	7907 mm	8320 mm	8807 mm
G Max digging reach at ground level	7740 mm	8140 mm	8640 mm
Min swing radius	2965 mm	2910 mm	2925 mm

Two-piece boom



Arm length	2100 mm	2500 mm	3000 mm
A Max digging height	9280 mm	9570 mm	9985 mm
B Max dumping height	6805 mm	7095 mm	7510 mm
C Max digging depth	4885 mm	5285 mm	5785 mm
D Max vertical wall digging depth	3555 mm	4000 mm	4495 mm
E Max digging depth of cut for 2440 mm level	4515 mm	4935 mm	5460 mm
F Max digging reach	8355 mm	8735 mm	9230 mm
G Max digging reach at ground level	8165 mm	8555 mm	9060 mm
Min swing radius	2755 mm	2855 mm	3220 mm

## Lifting capacity / mono boom / undercarriage width 2.55 m

Arm length	A	⊗		7.5 m		6.0 m		4.5 m		3.0 m		1.5 m		
		⊗	⊗	⊗	⊗	⊗	⊗	⊗	⊗	⊗	⊗	⊗	⊗	
 Without stabiliser	2100 mm	7.5 m	kg											
		6.0 m	kg	*2900	*2900									
		4.5 m	kg	*2650	2250									
		3.0 m	kg	2650	2000			3400	2550	*5150	4000			
		1.5 m	kg	2550	1950			3200	2400	4850	3550			
		0.0 m	kg	2650	1950			3150	2350	4650	3400	*7700	6000	
	2500 mm	-1.5 m	kg	2950	2200			3150	2300	4650	3350	8750	6000	*6350 *6350
		-3.0 m	kg	*3500	2850					*4600	3450	*6500	6100	
		7.5 m	kg											
		6.0 m	kg											
		4.5 m	kg	*2350	*2350			*2550	*2550					
		3.0 m	kg	*2250	2100			3450	2600					
3000 mm	1.5 m	kg	*2250	1850			3300	2550	5150	3850	*8000	7000		
	0.0 m	kg	*2350	1800			3200	2400	4850	3600	9150	6300		
	-1.5 m	kg	2400	1800			3150	2300	4650	3400	*8150	6000		
	-3.0 m	kg	2700	2000			3100	2250	4600	3300	8700	5950	*5750 *5750	
	7.5 m	kg	*2400	*2400										
	6.0 m	kg	*2100	*2100			*3350	2650						
 Front or rear blade	2100 mm	7.5 m	kg											
		6.0 m	kg	*2900	*2900									
		4.5 m	kg	*2650	2650			*4100	3000	*5150	4600			
		3.0 m	kg	*2650	2350			*4850	2900	*6000	4400	*8850	8100	
		1.5 m	kg	*2850	2250			*5100	2800	*6800	4200			
		0.0 m	kg	*3150	2300			*5100	2700	*7000	4000	*7700	7200	
	2500 mm	-1.5 m	kg	*3900	2550			*4450	2700	*6400	3950	*9200	7200	*6350 *6350
		-3.0 m	kg	*3500	3350					*4600	4050	*6500	*6500	
		7.5 m	kg											
		6.0 m	kg	*2350	*2350			*2550	*2550					
		4.5 m	kg	*2250	*2250			*4150	3000					
		3.0 m	kg	*2250	2150			*4650	2900	*5650	4450	*8000	*8000	
3000 mm	1.5 m	kg	*2350	2100			*5000	2850	*6600	4200	*10050	7550		
	0.0 m	kg	*2650	2100			*5150	2700	*7000	4000	*8150	7200		
	-1.5 m	kg	*3150	2350			*4700	2700	*6650	3900	*9800	7150	*5750 *5750	
	-3.0 m	kg	*3550	2950					*5250	3950	*7450	7200		
	7.5 m	kg	*2400	*2400										
	6.0 m	kg	*2100	*2100			*3350	3050						
 Rear outrigger	2100 mm	7.5 m	kg											
		6.0 m	kg	*2900	*2900									
		4.5 m	kg	*2650	*2650			*4100	3550	*5150	*5150			
		3.0 m	kg	*2650	*2650			*4850	3450	*6000	5250	*8850	*8850	
		1.5 m	kg	*2850	2700			*5100	3350	*6800	5050			
		0.0 m	kg	*3150	2750			*5100	3300	*7000	4850	*7700	*7700	
	2500 mm	-1.5 m	kg	*3900	3100			*4450	3250	*6400	4800	*9200	9050	*6350 *6350
		-3.0 m	kg	*3500	*3500					*4600	*4600	*6500	*6500	
		7.5 m	kg											
		6.0 m	kg	*2350	*2350			*2550	*2550					
		4.5 m	kg	*2250	*2250			*4150	3600					
		3.0 m	kg	*2250	*2250			*4650	3450	*5650	5350	*8000	*8000	
3000 mm	1.5 m	kg	*2350	*2350			*5000	3350	*6600	5100	*10050	9450		
	0.0 m	kg	*2650	2550			*5150	3300	*7000	4850	*8150	*8150		
	-1.5 m	kg	*3150	2850			*4700	3250	*6650	4800	*9800	9050	*5750 *5750	
	-3.0 m	kg	*3550	3550					*5250	4800	*7450	*7450		
	7.5 m	kg	*2400	*2400										
	6.0 m	kg	*2100	*2100			*3350	*3350						

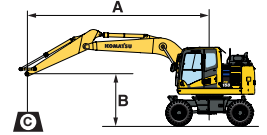

A – Reach from swing center

B – Bucket hook height

C – Lifting capacities, including bucket linkage (84 kg) and bucket cylinder (96 kg)

⊗ – Rating over front

⊗ – Rating over side

⊗ – Rating at maximum reach

When removing linkage or cylinder, lifting capacities can be increased by their respective weights.

\* Load is limited by hydraulic capacity rather than tipping. Ratings are based on ISO standard 10567. Rated loads do not exceed 87% of hydraulic lift capacity or 75% of tipping load.

Arm length	A B	7.5 m		6.0 m		4.5 m		3.0 m		1.5 m	

 Outrigger + blade	2100 mm	7.5 m	kg											
		6.0 m	kg	*2900	*2900									
		4.5 m	kg	*2650	*2650									
		3.0 m	kg	*2650	*2650									
		1.5 m	kg	*2850	*2850									
		0.0 m	kg	*3150	*3150									
	2500 mm	- 1.5 m	kg	*3900	3850									
		- 3.0 m	kg	*3500	*3500									
		7.5 m	kg											
		6.0 m	kg	*2350	*2350									
		4.5 m	kg	*2250	*2250									
		3.0 m	kg	*2250	*2250									
	3000 mm	1.5 m	kg	*2350	*2350									
		0.0 m	kg	*2650	*2650									
		- 1.5 m	kg	*3150	*3150									
		- 3.0 m	kg	*3550	*3550									
		7.5 m	kg	*2400	*2400									
		6.0 m	kg	*2100	*2100									
3000 mm	4.5 m	kg	*2000	*2000										
	3.0 m	kg	*2000	*2000	*3100	3000	*4350	4250	*5150	*5150				
	1.5 m	kg	*2050	*2050	*3650	3000	*4750	4150	*6200	*6200	*9700	*9700		
	0.0 m	kg	*2300	*2300	*3450	2900	*5000	4000	*6850	6100	*8500	*8500		
	- 1.5 m	kg	*2650	*2650			*4900	3900	*6750	6000	*10250	*10250	*5000	*5000
	- 3.0 m	kg	*3350	*3350			*3850	*3850	*5700	*5700	*8350	*8350	*8150	*8150

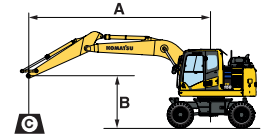

A - Reach from swing center

B - Bucket hook height

C - Lifting capacities, including bucket linkage (84 kg) and bucket cylinder (96 kg)

- Rating over front

- Rating over side



- Rating at maximum reach

When removing linkage or cylinder, lifting capacities can be increased by their respective weights.

\* Load is limited by hydraulic capacity rather than tipping. Ratings are based on ISO standard 10567. Rated loads do not exceed 87% of hydraulic lift capacity or 75% of tipping load.

 Outrigger front + rear	2100 mm	7.5 m	kg											
		6.0 m	kg	*2900	*2900									
		4.5 m	kg	*2650	*2650									
		3.0 m	kg	*2650	*2650									
		1.5 m	kg	*2850	*2850									
		0.0 m	kg	*3150	*3150									
	2500 mm	- 1.5 m	kg	*3900	*3900									
		- 3.0 m	kg	*3550	*3550									
		7.5 m	kg											
		6.0 m	kg	*2350	*2350									
		4.5 m	kg	*2250	*2250									
		3.0 m	kg	*2250	*2250									
	3000 mm	1.5 m	kg	*2350	*2350									
		0.0 m	kg	*2650	*2650									
		- 1.5 m	kg	*3150	*3150									
		- 3.0 m	kg	*3550	*3550									
		7.5 m	kg	*2400	*2400									
		6.0 m	kg	*2100	*2100									
3000 mm	4.5 m	kg	*2000	*2000										
	3.0 m	kg	*2000	*2000	*3100	*3100	*4350	*4350	*5150	*5150				
	1.5 m	kg	*2050	*2050	*3650	3500	*4750	*4750	*6200	*6200	*9700	*9700		
	0.0 m	kg	*2300	*2300	*3450	*3450	*5000	4800	*6850	*6850	*8500	*8500		
	- 1.5 m	kg	*2650	*2650			*4900	4750	*6750	*6750	*10250	*10250	*5000	*5000
	- 3.0 m	kg	*3350	*3350			*3850	*3850	*5700	*5700	*8350	*8350	*8150	*8150

## Lifting capacity / two-piece boom / undercarriage width 2.55 m

Arm length	A	⊗		7.5 m		6.0 m		4.5 m		3.0 m		1.5 m		
		B		⊗	⊗	⊗	⊗	⊗	⊗	⊗	⊗	⊗	⊗	
		⊗	⊗	⊗	⊗	⊗	⊗	⊗	⊗	⊗	⊗	⊗	⊗	
 Without stabiliser	2100 mm	7.5 m kg	*3550	*3550				*3750	*3750					
		6.0 m kg	*2950	2550		*3100	2550	*4050	4050					
		4.5 m kg	2700	2050		3400	2550	*5250	3950					
		3.0 m kg	2450	1800		3300	2450	5000	3750					
		1.5 m kg	2350	1750		3150	2400	4750	3450					
		0.0 m kg	2400	1800		3100	2300	4600	3300					
	- 1.5 m kg	2700	2000		3100	2250	4550	3300	*8500	5900				
	- 3.0 m kg													
	2500 mm	7.5 m kg	*2850	*2850				*3950	*3950					
		6.0 m kg	*2400	2250		3450	2600							
		4.5 m kg	*2300	1900		3450	2550	*4950	4000					
		3.0 m kg	*2250	1700	2350	1800	3300	2500	5100	3750				
1.5 m kg		2200	1650	2300	1750	3150	2400	4800	3500					
0.0 m kg		2250	1650	2250	1700	3100	2250	4600	3300	*5400	*5400			
- 1.5 m kg	2450	1800			3050	2250	4550	3300	*8500	5850				
- 3.0 m kg	3150	2350					4600	3300						
3000 mm	7.5 m kg	*2450	*2450											
	6.0 m kg	*2100	1950		3450	2650								
	4.5 m kg	*2000	1650	2400	1800	3450	2550	*3850	*3850					
	3.0 m kg	*2000	1500	2350	1750	3300	2450	5100	3800					
	1.5 m kg	1950	1450	2250	1650	3150	2350	4800	3500					
	0.0 m kg	2000	1450	2250	1650	3000	2250	4550	3300	*5650	*5650			
- 1.5 m kg	2150	1600	2200	1650	3000	2150	4450	3150	*7700	5700	*3900	*3900		
- 3.0 m kg	2550	1900			3000	2150	4450	3150	*7800	5700				
 Front or rear blade	2100 mm	7.5 m kg	*3550	*3550				*3750	*3750					
		6.0 m kg	*2950	*2950		*3100	3000	*4050	*4050					
		4.5 m kg	*2700	2400		*4150	3000	*5250	4550					
		3.0 m kg	*2650	2100		*4350	2850	*5900	4350					
		1.5 m kg	*2750	2050		*4750	2750	*6850	4050					
		0.0 m kg	*3000	2100		*5000	2700	*6900	3950					
	- 1.5 m kg	*3550	2350		*4450	2700	*6200	3900	*8500	7100				
	- 3.0 m kg													
	2500 mm	7.5 m kg	*2850	*2850				*3950	*3950					
		6.0 m kg	*2400	*2400		*3800	3000							
		4.5 m kg	*2300	2200		*4000	3000	*4950	4650					
		3.0 m kg	*2250	1950	*3350	2100	*4250	2900	*5650	4350				
1.5 m kg		*2300	1900	*3650	2000	*4600	2750	*6650	4100					
0.0 m kg		*2550	1950	*3400	1950	*5000	2700	*6950	3900	*5400	*5400			
- 1.5 m kg	*2950	2150			*4650	2650	*6400	3900	*8500	7050				
- 3.0 m kg	*3400	2750					*5000	3900						
3000 mm	7.5 m kg	*2450	*2450											
	6.0 m kg	*2100	*2100		*3700	3050								
	4.5 m kg	*2000	1950	*3050	2100	*3800	3000	*3850	*3850					
	3.0 m kg	*2000	1750	*3300	2050	*4000	2850	*5250	4400					
	1.5 m kg	*2000	1700	*3400	1950	*4350	2750	*6150	4100					
	0.0 m kg	*2200	1750	*3650	1950	*4750	2600	*6800	3900	*5650	*5650			
- 1.5 m kg	*2500	1900	*3350	1950	*4750	2550	*6550	3750	*7700	6900	*3850	*3850		
- 3.0 m kg	*2850	2250			*3850	2550	*5500	3750	*7800	6950				
 Rear outrigger	2100 mm	7.5 m kg	*3550	*3550				*3750	*3750					
		6.0 m kg	*2950	*2950		*3100	*3100	*4050	*4050					
		4.5 m kg	*2700	*2700		*4150	3550	*5250	*5250					
		3.0 m kg	*2650	2550		*4350	3450	*5900	5250					
		1.5 m kg	*2750	2450		*4750	3300	*6850	4950					
		0.0 m kg	*3000	2550		*5000	3250	*6900	4800					
	- 1.5 m kg	*3550	2850		*4450	3200	*6200	4800	*8500	*8500				
	- 3.0 m kg													
	2500 mm	7.5 m kg	*2850	*2850				*3950	*3950					
		6.0 m kg	*2400	*2400		*3800	3600							
		4.5 m kg	*2300	*2300		*4000	3550	*4950	*4950					
		3.0 m kg	*2250	*2250	*3350	2450	*4250	3450	*5650	5250				
1.5 m kg		*2300	2300	*3650	2400	*4600	3300	*6650	5000					
0.0 m kg		*2550	2350	*3400	2400	*5000	3250	*6950	4800	*5400	*5400			
- 1.5 m kg	*2950	2550			*4650	3200	*6400	4750	*8500	*8500				
- 3.0 m kg	*3400	3300					*5000	4800						
3000 mm	7.5 m kg	*2450	*2450											
	6.0 m kg	*2100	*2100		*3700	3600								
	4.5 m kg	*2000	*2000	*3050	2500	*3800	3600	*3850	*3850					
	3.0 m kg	*2000	*2000	*3300	2450	*4000	3450	*5250	*5250					
	1.5 m kg	*2000	*2000	*3400	2400	*4350	3300	*6150	5000					
	0.0 m kg	*2200	2100	*3650	2350	*4750	3150	*6800	4750	*5650	*5650			
- 1.5 m kg	*2500	2250	*3350	2300	*4750	3100	*6550	4650	*7700	*7700	*3850	*3850		
- 3.0 m kg	*2850	2700			*3850	3150	*5500	4650	*7800	*7800				

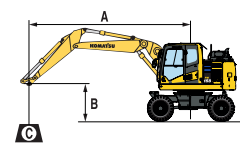

- A – Reach from swing center
  - B – Bucket hook height
  - C – Lifting capacities, including bucket linkage (84 kg) and bucket cylinder (96 kg)
- Rating over front
  - Rating over side
  - Rating at maximum reach

When removing linkage or cylinder, lifting capacities can be increased by their respective weights.

\* Load is limited by hydraulic capacity rather than tipping. Ratings are based on ISO standard 10567. Rated loads do not exceed 87% of hydraulic lift capacity or 75% of tipping load.



Arm length	A B	⊗		7.5 m		6.0 m		4.5 m		3.0 m		1.5 m	
		⊗	⊗	⊗	⊗	⊗	⊗	⊗	⊗	⊗	⊗	⊗	⊗

 Outrigger + blade	2100 mm	7.5 m	kg	*3550	*3550				*3750	*3750				
		6.0 m	kg	*2950	*2950			*3100	*3100	*4050	*4050			
		4.5 m	kg	*2700	*2700			*4150	*4150	*5250	*5250			
		3.0 m	kg	*2650	*2650			*4350	4200	*5900	*5900			
		1.5 m	kg	*2750	*2750			*4750	4100	*6850	6250			
		0.0 m	kg	*3000	*3000			*5000	4050	*6900	6050			
	2500 mm	- 1.5 m	kg	*3550	3500			*4450	4000	*6200	6000	*8500	*8500	
		- 3.0 m	kg											
		7.5 m	kg	*2850	*2850					*3950	*3950			
		6.0 m	kg	*2400	*2400			*3800	*3800					
		4.5 m	kg	*2300	*2300			*4000	*4000	*4950	*4950			
		3.0 m	kg	*2250	*2250	*3350	3000	*4250	*4250	*5650	*5650			
3000 mm	1.5 m	kg	*2300	*2300	*3650	3000	*4600	4100	*6650	6300				
	0.0 m	kg	*2550	*2550	*3400	2950	*5000	4050	*6950	6050	*5400	*5400		
	- 1.5 m	kg	*2950	*2950			*4650	4000	*6400	6000	*8500	*8500		
	- 3.0 m	kg	*3400	*3400					*5000	*5000				
	7.5 m	kg	*2450	*2450										
	6.0 m	kg	*2100	*2100			*3700	*3700						

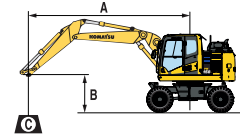

A - Reach from swing center

B - Bucket hook height

C - Lifting capacities, including bucket linkage (84 kg) and bucket cylinder (96 kg)

⊗ - Rating over front

⊗ - Rating over side

⊗ - Rating at maximum reach

When removing linkage or cylinder, lifting capacities can be increased by their respective weights.

\* Load is limited by hydraulic capacity rather than tipping. Ratings are based on ISO standard 10567. Rated loads do not exceed 87% of hydraulic lift capacity or 75% of tipping load.

 Outrigger front + rear	2100 mm	7.5 m	kg	*3550	*3550				*3750	*3750				
		6.0 m	kg	*2950	*2950			*3100	*3100	*4050	*4050			
		4.5 m	kg	*2700	*2700			*4150	*4150	*5250	*5250			
		3.0 m	kg	*2650	*2650			*4350	*4350	*5900	*5900			
		1.5 m	kg	*2750	*2750			*4750	*4750	*6850	*6850			
		0.0 m	kg	*3000	*3000			*5000	4850	*6900	*6900			
	2500 mm	- 1.5 m	kg	*3550	*3550			*4450	*4450	*6200	*6200	*8500	*8500	
		- 3.0 m	kg											
		7.5 m	kg	*2850	*2850					*3950	*3950			
		6.0 m	kg	*2400	*2400			*3800	*3800					
		4.5 m	kg	*2300	*2300			*4000	*4000	*4950	*4950			
		3.0 m	kg	*2250	*2250	*3350	*3350	*4250	*4250	*5650	*5650			
3000 mm	1.5 m	kg	*2300	*2300	*3650	3600	*4600	*4600	*6650	*6650				
	0.0 m	kg	*2550	*2550	*3400	*3400	*5000	4800	*6950	*6950	*5400	*5400		
	- 1.5 m	kg	*2950	*2950			*4650	*4650	*6400	*6400	*8500	*8500		
	- 3.0 m	kg	*3400	*3400					*5000	*5000				
	7.5 m	kg	*2450	*2450										
	6.0 m	kg	*2100	*2100			*3700	*3700						

## Lifting capacity / mono boom / undercarriage width 2.75 m

Arm length	A	7.5 m		6.0 m		4.5 m		3.0 m		1.5 m	

	2100 mm	7.5 m	kg												
		6.0 m	kg	*2900		*2900									
		4.5 m	kg	*2650	2500			3450	2850	*5150	4350				
		3.0 m	kg	*2650	2200			3350	2750	5150	4200	*8850	7650		
		1.5 m	kg	2600	2100			3300	2650	4950	3900				
		0.0 m	kg	2700	2150			3200	2550	4750	3750	*7700	6750		
	2500 mm	-1.5 m	kg	3000	2450			3150	2550	4700	3750	8900	6750	*6350	*6350
		-3.0 m	kg	*3500	3150					*4600	3800	*6500	*6500		
		7.5 m	kg												
		6.0 m	kg	*2350	*2350			*2550	*2550						
		4.5 m	kg	*2250	*2250			3450	2850						
		3.0 m	kg	*2250	2050			3400	2750	5250	4200	*8000	7850		
3000 mm	1.5 m	kg	*2350	1950			3300	2650	4950	3950	9300	7050			
	0.0 m	kg	2450	2000			3150	2550	4750	3750	*8150	6750			
	-1.5 m	kg	2750	2200			3150	2550	4650	3700	8850	6700	*5750	*5750	
	-3.0 m	kg	3450	2750					4700	3750	*7450	6750			
	7.5 m	kg													
	6.0 m	kg	*2400	*2400			*2100	*2100	*3350	2900					



Without stabiliser

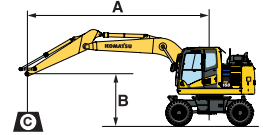

A – Reach from swing center

B – Bucket hook height

C – Lifting capacities, including bucket linkage (84 kg) and bucket cylinder (96 kg)

– Rating over rear/front

– Rating over side

– Rating at maximum reach

When removing linkage or cylinder, lifting capacities can be increased by their respective weights.

\* Load is limited by hydraulic capacity rather than tipping. Ratings are based on ISO standard 10567. Rated loads do not exceed 87% of hydraulic lift capacity or 75% of tipping load.

	2100 mm	7.5 m	kg												
		6.0 m	kg	*2900		*2900									
		4.5 m	kg	*2650	2550			*4100	3300	*5150	5100				
		3.0 m	kg	*2650	2550			*4850	3200	*6000	4850	*8850	*8850		
		1.5 m	kg	*2850	2450			*5100	3100	*6800	4600				
		0.0 m	kg	*3150	2550			*5100	3000	*7000	4450	*7700	*7700		
	2500 mm	-1.5 m	kg	*3900	2850			*4450	3000	*6400	4400	*9200	8150	*6350	*6350
		-3.0 m	kg	*3500	*3500					*4600	4450	*6500	*6500		
		7.5 m	kg												
		6.0 m	kg	*2350	*2350			*2550	*2550						
		4.5 m	kg	*2250	*2250			*4150	3300						
		3.0 m	kg	*2250	*2250			*4650	3200	*5650	4900	*8000	*8000		
3000 mm	1.5 m	kg	*2350	2250			*5000	3100	*6600	4650	*10050	8550			
	0.0 m	kg	*2650	2350			*5150	3000	*7000	4450	*8150	8150			
	-1.5 m	kg	*3150	2600			*4700	2950	*6650	4350	*9800	8100	*5750	*5750	
	-3.0 m	kg	*3550	3250					*5250	4400	*7450	*7450			
	7.5 m	kg													
	6.0 m	kg	*2400	*2400			*2100	*2100	*3350	3300					



Front or rear blade

	2100 mm	7.5 m	kg												
		6.0 m	kg	*2900		*2900									
		4.5 m	kg	*2650	*2650			*4100	3900	*5150	*5150				
		3.0 m	kg	*2650	*2650			*4850	3800	*6000	5850	*8850	*8850		
		1.5 m	kg	*2850	*2850			*5100	3700	*6800	5550				
		0.0 m	kg	*3150	3000			*5100	3600	*7000	5400	*7700	*7700		
	2500 mm	-1.5 m	kg	*3900	3400			*4450	3600	*6400	5350	*9200	*9200	*6350	*6350
		-3.0 m	kg	*3500	*3500					*4600	*4600	*6500	*6500		
		7.5 m	kg												
		6.0 m	kg	*2350	*2350			*2550	*2550						
		4.5 m	kg	*2250	*2250			*4150	3900						
		3.0 m	kg	*2250	*2250			*4650	3800	*5650	*5650	*8000	*8000		
3000 mm	1.5 m	kg	*2350	*2350			*5000	3700	*6600	5600	*10050	*10050			
	0.0 m	kg	*2650	*2650			*5150	3600	*7000	5400	*8150	*8150			
	-1.5 m	kg	*3150	3100			*4700	3550	*6650	5300	*9800	*9800	*5750	*5750	
	-3.0 m	kg	*3550	*3550					*5250	*5250	*7450	*7450			
	7.5 m	kg													
	6.0 m	kg	*2400	*2400			*2100	*2100	*3350	*3350					



Rear outrigger

Arm length	A B	7.5 m		6.0 m		4.5 m		3.0 m		1.5 m	

 Outrigger + blade	2100 mm	7.5 m	kg										
		6.0 m	kg	*2900	*2900								
		4.5 m	kg	*2650	*2650								
		3.0 m	kg	*2650	*2650								
		1.5 m	kg	*2850	*2850								
		0.0 m	kg	*3150	*3150								
	2500 mm	- 1.5 m	kg	*3900	*3900								
		- 3.0 m	kg	*3500	*3500								
		7.5 m	kg										
		6.0 m	kg	*2350	*2350								
		4.5 m	kg	*2250	*2250								
		3.0 m	kg	*2250	*2250								
	3000 mm	1.5 m	kg	*2350	*2350								
		0.0 m	kg	*2650	*2650								
		- 1.5 m	kg	*3150	*3150								
		- 3.0 m	kg	*3550	*3550								
		7.5 m	kg	*2400	*2400								
		6.0 m	kg	*2100	*2100								
3000 mm	4.5 m	kg	*2000	*2000									
	3.0 m	kg	*2000	*2000	*3100	*3100	*4350	*4350	*5150	*5150			
	1.5 m	kg	*2050	*2050	*3650	3250	*4750	4500	*6200	*6200	*9700	*9700	
	0.0 m	kg	*2300	*2300	*3450	3200	*5000	4400	*6850	6750	*8500	*8500	
	- 1.5 m	kg	*2650	*2650			*4900	4350	*6750	6600	*10250	*10250	
	- 3.0 m	kg	*3350	*3350			*3850	*3850	*5700	*5700	*8350	*8350	

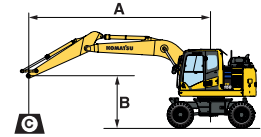

A - Reach from swing center

B - Bucket hook height

C - Lifting capacities, including bucket linkage (84 kg) and bucket cylinder (96 kg)

- Rating over rear/front

- Rating over side



- Rating at maximum reach

When removing linkage or cylinder, lifting capacities can be increased by their respective weights.

\* Load is limited by hydraulic capacity rather than tipping. Ratings are based on ISO standard 10567. Rated loads do not exceed 87% of hydraulic lift capacity or 75% of tipping load.

 Outrigger front + rear	2100 mm	7.5 m	kg										
		6.0 m	kg	*2900	*2900								
		4.5 m	kg	*2650	*2650								
		3.0 m	kg	*2650	*2650								
		1.5 m	kg	*2850	*2850								
		0.0 m	kg	*3150	*3150								
	2500 mm	- 1.5 m	kg	*3900	*3900								
		- 3.0 m	kg	*3550	*3550								
		7.5 m	kg										
		6.0 m	kg	*2350	*2350								
		4.5 m	kg	*2250	*2250								
		3.0 m	kg	*2250	*2250								
	3000 mm	1.5 m	kg	*2350	*2350								
		0.0 m	kg	*2650	*2650								
		- 1.5 m	kg	*3150	*3150								
		- 3.0 m	kg	*3550	*3550								
		7.5 m	kg	*2400	*2400								
		6.0 m	kg	*2100	*2100								
3000 mm	4.5 m	kg	*2000	*2000									
	3.0 m	kg	*2000	*2000	*3100	*3100	*4350	*4350	*5150	*5150			
	1.5 m	kg	*2050	*2050	*3650	*3650	*4750	*4750	*6200	*6200	*9700	*9700	
	0.0 m	kg	*2300	*2300	*3450	*3450	*5000	*5000	*6850	*6850	*8500	*8500	
	- 1.5 m	kg	*2650	*2650			*4900	*4900	*6750	*6750	*10250	*10250	
	- 3.0 m	kg	*3350	*3350			*3850	*3850	*5700	*5700	*8350	*8350	

## Lifting capacity / two-piece boom / undercarriage width 2.75 m

Arm length	A	⊗		7.5 m		6.0 m		4.5 m		3.0 m		1.5 m		
		⊗	⊗	⊗	⊗	⊗	⊗	⊗	⊗	⊗	⊗	⊗	⊗	
 Without stabiliser	2100 mm	7.5 m	kg	*3550	*3550			*3750	*3750					
		6.0 m	kg	*2950	2800		*3100	2800	*4050	*4050				
		4.5 m	kg	*2700	2250		3450	2800	*5250	4350				
		3.0 m	kg	2500	2000		3350	2700	5100	4100				
		1.5 m	kg	2400	1950		3250	2600	4850	3850				
		0.0 m	kg	2450	2000		3150	2550	4650	3700				
	2500 mm	-1.5 m	kg	2750	2250		3150	2550	4650	3650	*8500	6650		
		-3.0 m	kg											
		7.5 m	kg	*2850	*2850				*3950	*3950				
		6.0 m	kg	*2400	*2400		3500	2850						
		4.5 m	kg	*2300	2100		3450	2850	*4950	4400				
		3.0 m	kg	*2250	1850	2400	1950	3350	2700	5150	4150			
	3000 mm	1.5 m	kg	2250	1800	2350	1900	3250	2600	4850	3900			
		0.0 m	kg	2250	1850	2300	1850	3150	2550	4650	3700	*5400	*5400	
		-1.5 m	kg	2500	2000			3100	2500	4650	3650	*8500	6600	
		-3.0 m	kg	3250	2600					4650	3700			
		7.5 m	kg	*2450	*2450									
		6.0 m	kg	*2100	*2100		3550	2900						
 Front or rear blade	2100 mm	7.5 m	kg	*3550	*3550			*3750	*3750					
		6.0 m	kg	*2950	*2950		*3100	*3100	*4050	*4050				
		4.5 m	kg	*2700	2600		*4150	3250	*5250	5050				
		3.0 m	kg	*2650	2350		*4350	3150	*5900	4800				
		1.5 m	kg	*2750	2250		*4750	3050	*6850	4500				
		0.0 m	kg	*3000	2350		*5000	3000	*6900	4350				
	2500 mm	-1.5 m	kg	*3550	2600		*4450	2950	*6200	4350	*8500	8100		
		-3.0 m	kg											
		7.5 m	kg	*2850	*2850				*3950	*3950				
		6.0 m	kg	*2400	*2400		*3800	3300						
		4.5 m	kg	*2300	*2300		*4000	3300	*4950	*4950				
		3.0 m	kg	*2250	2200	*3350	2250	*4250	3150	*5650	4800			
	3000 mm	1.5 m	kg	*2300	2100	*3650	2250	*4600	3050	*6650	4550			
		0.0 m	kg	*2550	2150	*3400	2200	*5000	2950	*6950	4350	*5400	*5400	
		-1.5 m	kg	*2950	2400			*4650	2900	*6400	4350	*8500	8000	
		-3.0 m	kg	*3400	3050					*5000	4350			
		7.5 m	kg	*2450	*2450									
		6.0 m	kg	*2100	*2100		*3700	3350						
 Rear outrigger	2100 mm	7.5 m	kg	*3550	*3550			*3750	*3750					
		6.0 m	kg	*2950	*2950		*3100	*3100	*4050	*4050				
		4.5 m	kg	*2700	*2700		*4150	3900	*5250	*5250				
		3.0 m	kg	*2650	*2650		*4350	3750	*5900	5750				
		1.5 m	kg	*2750	2700		*4750	3650	*6850	5500				
		0.0 m	kg	*3000	2800		*5000	3600	*6900	5350				
	2500 mm	-1.5 m	kg	*3550	3150		*4450	3550	*6200	5300	*8500	*8500		
		-3.0 m	kg											
		7.5 m	kg	*2850	*2850				*3950	*3950				
		6.0 m	kg	*2400	*2400		*3800	*3800						
		4.5 m	kg	*2300	*2300		*4000	3900	*4950	*4950				
		3.0 m	kg	*2250	*2250	*3350	2700	*4250	3750	*5650	*5650			
	3000 mm	1.5 m	kg	*2300	*2300	*3650	2700	*4600	3650	*6650	5550			
		0.0 m	kg	*2550	*2550	*3400	2650	*5000	3550	*6950	5350	*5400	*5400	
		-1.5 m	kg	*2950	2850			*4650	3500	*6400	5250	*8500	*8500	
		-3.0 m	kg	*3400	*3400					*5000	*5000			
		7.5 m	kg	*2450	*2450									
		6.0 m	kg	*2100	*2100		*3700	*3700						

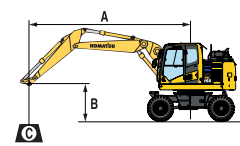

- A - Reach from swing center
- B - Bucket hook height
- C - Lifting capacities, including bucket linkage (84 kg) and bucket cylinder (96 kg)
- ⊗ - Rating over rear/front
- ⊗ - Rating over side
- ⊗ - Rating at maximum reach

When removing linkage or cylinder, lifting capacities can be increased by their respective weights.

\* Load is limited by hydraulic capacity rather than tipping. Ratings are based on ISO standard 10567. Rated loads do not exceed 87% of hydraulic lift capacity or 75% of tipping load.

Arm length	A B	⊗		7.5 m		6.0 m		4.5 m		3.0 m		1.5 m	
		⊗	⊗	⊗	⊗	⊗	⊗	⊗	⊗	⊗	⊗	⊗	⊗

 Outrigger + blade	2100 mm	7.5 m	kg	*3550	*3550				*3750	*3750			
		6.0 m	kg	*2950	*2950			*3100	*3100	*4050	*4050		
		4.5 m	kg	*2700	*2700			*4150	*4150	*5250	*5250		
		3.0 m	kg	*2650	*2650			*4350	*4350	*5900	*5900		
		1.5 m	kg	*2750	*2750			*4750	4500	*6850	*6850		
		0.0 m	kg	*3000	*3000			*5000	4450	*6900	6750		
	2500 mm	- 1.5 m	kg	*3550	*3550			*4450	4400	*6200	*6200	*8500	*8500
		- 3.0 m	kg										
		7.5 m	kg	*2850	*2850					*3950	*3950		
		6.0 m	kg	*2400	*2400			*3800	*3800				
		4.5 m	kg	*2300	*2300			*4000	*4000	*4950	*4950		
		3.0 m	kg	*2250	*2250	*3350	3300	*4250	*4250	*5650	*5650		
3000 mm	1.5 m	kg	*2300	*2300	*3650	3300	*4600	4500	*6650	*6650			
	0.0 m	kg	*2550	*2550	*3400	3250	*5000	4400	*6950	6750	*5400	*5400	
	- 1.5 m	kg	*2950	*2950			*4650	4350	*6400	*6400	*8500	*8500	
	- 3.0 m	kg	*3400	*3400					*5000	*5000			
	7.5 m	kg	*2450	*2450									
	6.0 m	kg	*2100	*2100			*3700	*3700					

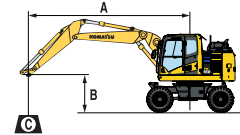

A - Reach from swing center

B - Bucket hook height

C - Lifting capacities, including bucket linkage (84 kg) and bucket cylinder (96 kg)

⊗ - Rating over rear/front

⊗ - Rating over side

⊗ - Rating at maximum reach

When removing linkage or cylinder, lifting capacities can be increased by their respective weights.

\* Load is limited by hydraulic capacity rather than tipping. Ratings are based on ISO standard 10567. Rated loads do not exceed 87% of hydraulic lift capacity or 75% of tipping load.

 Outrigger front + rear	2100 mm	7.5 m	kg	*3550	*3550				*3750	*3750			
		6.0 m	kg	*2950	*2950			*3100	*3100	*4050	*4050		
		4.5 m	kg	*2700	*2700			*4150	*4150	*5250	*5250		
		3.0 m	kg	*2650	*2650			*4350	*4350	*5900	*5900		
		1.5 m	kg	*2750	*2750			*4750	*4750	*6850	*6850		
		0.0 m	kg	*3000	*3000			*5000	*5000	*6900	*6900		
	2500 mm	- 1.5 m	kg	*3550	*3550			*4450	*4450	*6200	*6200	*8500	*8500
		- 3.0 m	kg										
		7.5 m	kg	*2850	*2850					*3950	*3950		
		6.0 m	kg	*2400	*2400			*3800	*3800				
		4.5 m	kg	*2300	*2300			*4000	*4000	*4950	*4950		
		3.0 m	kg	*2250	*2250	*3350	*3350	*4250	*4250	*5650	*5650		
3000 mm	1.5 m	kg	*2300	*2300	*3650	*3650	*4600	*4600	*6650	*6650			
	0.0 m	kg	*2550	*2550	*3400	*3400	*5000	*5000	*6950	*6950	*5400	*5400	
	- 1.5 m	kg	*2950	*2950			*4650	*4650	*6400	*6400	*8500	*8500	
	- 3.0 m	kg	*3400	*3400					*5000	*5000			
	7.5 m	kg	*2450	*2450									
	6.0 m	kg	*2100	*2100			*3700	*3700					

# Standard and optional equipment

## Engine

Komatsu SAA4D107E-5 turbocharged common rail direct injection diesel engine	●
EU Stage V compliant	●
Suction type cooling fan	●
Automatic engine warm-up system	●
Engine overheat prevention system	●
Auto-deceleration function	●
Adjustable idle shutdown	●
Engine ignition can be password secured on request	●
Batteries 2 × 12 V/125 Ah	●
Alternator 24 V / 85 A	●
Starter motor 24 V / 4.5 kW	●

## Hydraulic system

Electronic closed-centre load sensing (E-CLSS) hydraulic system (HydraMind)	●
Pump and engine mutual control (PEMC) system	●
6-working mode selection system; Power, Lifting/Fine Operation, Breaker, Economy, Attachment Power and Attachment Economy	●
PowerMax function	●
Adjustable PPC wrist control levers for arm, boom, bucket and swing, with sliding proportional control for attachments and 5 auxiliary buttons, with FNR switch	●
Additional hydraulic circuit (HCU-B)	●
Additional hydraulic circuit (HCU-C)	○
Extension HCU-C to HCU-D	○
Komatsu Integrated Attachment Control (KIAC)	○
Boom suspension system (ECSS)	○
Prepared for hydraulic quick-coupler	○

## Undercarriage

Parallel blade (front and/or rear) with cylinder protection	○
2 or 4 outriggers with cylinder protection, individually adjustable	○
Limited-slip differential (LSD)	○
Twin tyres 10.00-20 16 PR	○
Twin tyres (solid tyres) 10.00-20	○
Twin tyres 315/70 R22.5	○
Single tyres 445/70 R19.5	○
Single tyres 710/40 22.5	○
Trailer hitches	○
Fenders	○

## Cabin

SpaceCab™; ROPS, highly pressurised and tightly sealed hyper viscous mounted cab with tinted safety glass windows, large roof window with sun shade, pull-up type front window with locking device, removable lower window, front window wiper with intermittent feature, sun roller blind, cigarette lighter, luggage shelf, floor mat	●
Heated air suspension seat with lumbar support, arm rests and retractable seat belt	●
Automatic climate control system	●
12/24 Volt power supplies	●
Beverage holder and magazine rack	●
Hot and cool box	●
Adjustable steering column	●
Premium comfort seat	○
DAB+ radio with Bluetooth®, USB, AUX and hands-free kit	○
Heated, adjustable, suspended seat	○
Lower wiper	○
Rain visor (not with OPG)	○
Joystick steering system	○

## Safety equipment

KomVision surround view system	●
Electric horn	●
Overload warning device	●
Lockable fuel cap and covers	●
Audible travel alarm	●
Large handrails, rear-view mirrors	●
Battery main switch	●
Boom safety valves	●
Arm safety valve	●
Adjust cylinder safety valve	●
OPG Level II front guard (FOPS)	○
OPG Level II top guard (FOPS)	○
Audible travel alarm (white noise version)	○

## Lighting system

Standard halogen working lights package	●
LED working lights package	○
Advanced LED working lights package	○
Beacon	○

### Service and maintenance

Automatic fuel line de-aeration	●
Double element type air cleaner with dust indicator and auto dust evacuator	●
Komtrax – Komatsu wireless monitoring system (4G)	●
Multifunction video compatible colour monitor with Equipment Management and Monitoring System (EMMS) and efficiency guidance	●
Toolkit	●
Komatsu Care – a maintenance program for Komatsu customers	●
Remote greasing bar	●
Automatic greasing system	○

### Drives and brakes

Fully automatic 3-speed transmission driving through front and rear planetary axles	●
Oscillating front axle (10°) with automatic and manual cylinder locking	●
Cruise control	●
2.55 m wide undercarriage	●
2.75 m wide undercarriage	○
20, 25 or 35 km/h speed limitation	○
Transmission guard	○
Automatic digging brake	○

### Work equipment

Mono boom	○
Two-piece boom	○
2100 mm; 2500 mm; 3000 mm arms	○
Clamshell grip bar	○
Lehnhoff quick-couplers	○
Lehnhoff buckets	○

### Other equipment

Standard counterweight	●
Electric refuelling pump with automatic shut-off function	●
Single chassis tool box	●
Additional chassis tool box	○
Biodegradable oil for hydraulic system	○
Customised paint	○
License plate holder	○

Further equipment on request

- standard equipment
- optional equipment

This specification sheet may contain attachments and optional equipment that are not available in your area. Please consult your local Komatsu distributor for those items you may require. Materials and specifications are subject to change without notice.

---

Your Komatsu partner:

**KOMATSU**

[komatsu.eu](https://www.komatsu.eu)

